

# INTERLINE

INTERLINE BALI Ø 5,30 - 1,36 m

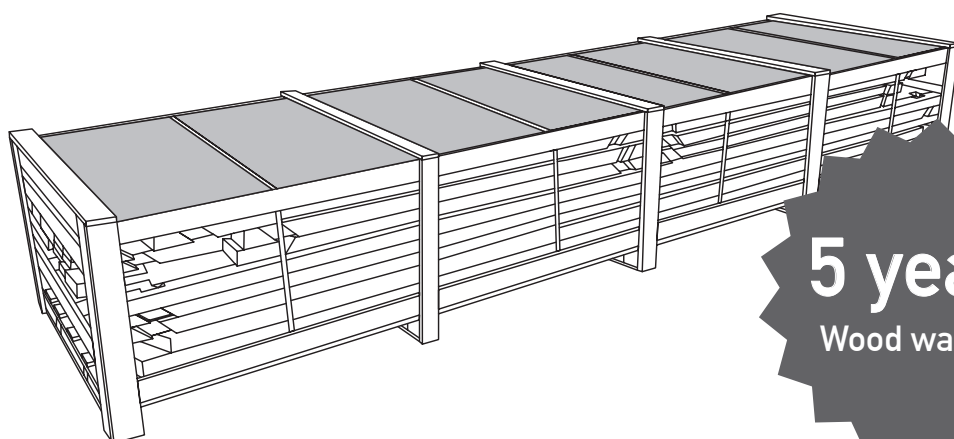
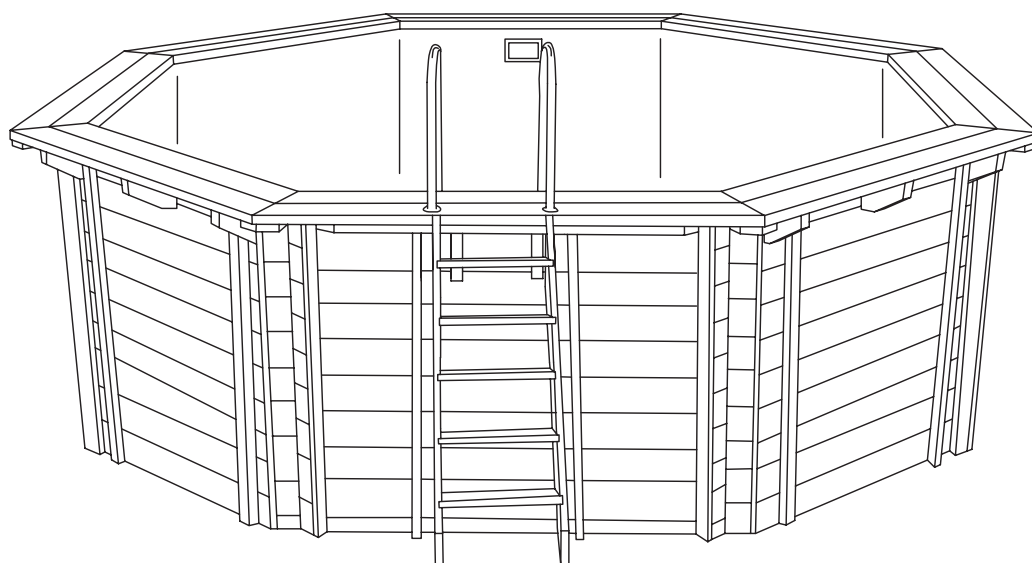

**5 years**  
Wood warranty

- PL Instrukcja montażu
- FR Notice de montage
- GB Assembly instructions
- IT Istruzioni di montaggio
- DE Montageanleitung
- NL Montage-instructies

Objętość wody w basenie 17,67 m<sup>3</sup>  
Le volume de l'eau dans la piscine 17,67 m<sup>3</sup>  
Water capacity in the pool 17,67 m<sup>3</sup>  
Il volume di acqua in piscina 17,67 m<sup>3</sup>  
Volumen von Wasser im Schwimmbecken 17,67 m<sup>3</sup>  
Inhoud van het zwembad 17,67 m<sup>3</sup>

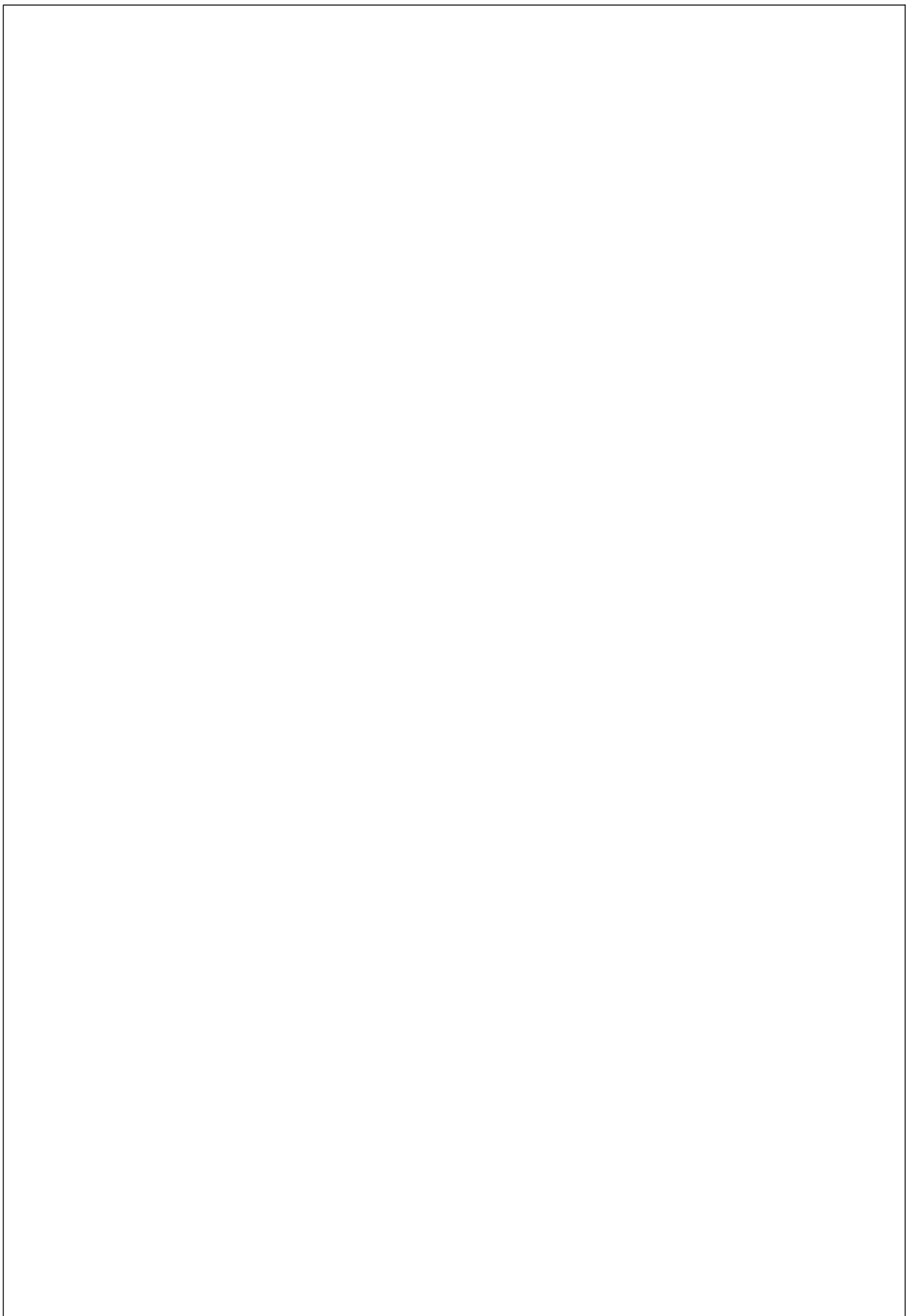

**(PL)** Instrukcja montażu

**(GB)** Assembly instructions

**(D)** Montageanleitung

**(FR)** Notice de montage

**(IT)** Istruzioni di montaggio

**(NL)** Montage-instructies



**(PL)** Przed przystąpieniem do montażu zapoznaj się z instrukcją.

**(FR)** Avant le montage lisez attentivement la notice.

**(GB)** Read carefully pool installation manual before the installation.

**(IT)** Prima del montaggio è necessario consultare il manuale.

**(D)** Vor der Montage machen Sie sich bitte mit der Bedienungsanleitung bekannt.

**(NL)** Lees aandachtig de montage instructie van het zwembad voor de installatie.

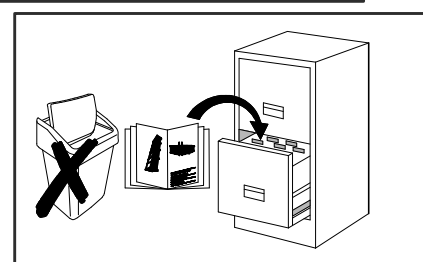
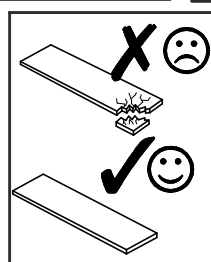
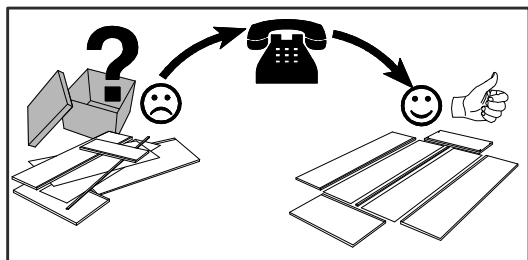
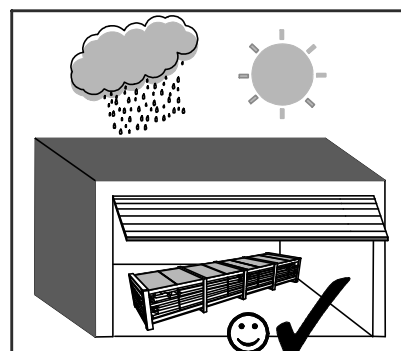
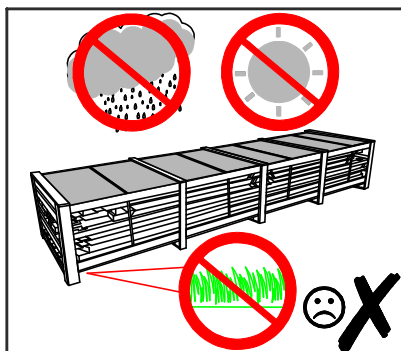
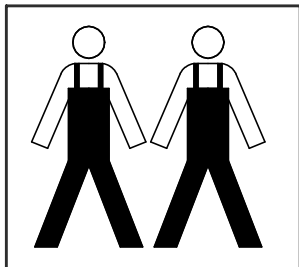
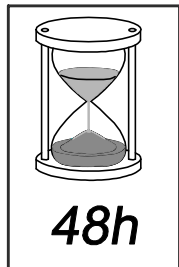

**UWAGA /REMARQUE /NOTE/ ATATTENZIONE /HINWEIS /LETOP**

**(PL)** Montaż wykonać w przeciągu 3 dni od rozpakowania struktury.

**(FR)** Il faut monter la structure au cours de 3 jours de l'ouverture du colis.

**(GB)** Installation should be finished within 3 days from opening the package.

**(IT)** Il montaggio effettuare entro 3 giorni dal disimballo della struttura.

**(D)** Die Montage ist innerhalb von 3 Tagen zu machen, nachdem die Konstruktion geöffnet wird.

**(NL)** De installatie moet worden afgewerkt binnen 3 dagen na het openen van de verpakking.

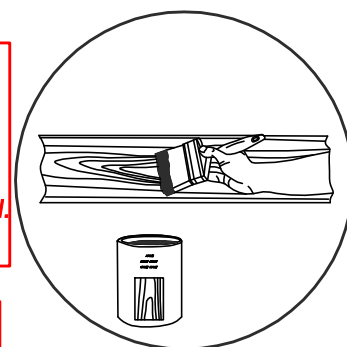

**UWAGA /REMARQUE /NOTE/ ATATTENZIONE /HINWEIS /LETOP**

**(PL)** Brak corocznej konserwacji struktury powoduje utratę gwarancji.

**(FR)** Le manque de la conseravtion annuelle de la structure cause la perte de la garantie.

**(GB)** Lack of once a year conservation of the structure causes loss of warranty.

**(IT)** Mancanza della manutenzione annuale causa la perdita di garanzia.

**(D)** Keine jährliche Wartung der Konstruktion macht das, das die Garantie verloren geht.

**(NL)** Behandel elk jaar de buitenkant van het zwembad met een beits, anders vervalt de garantie.



**UWAGA /REMARQUE /NOTE/ ATATTENZIONE /HINWEIS /LETOP**

**(PL)** Nie pozostawiać dzieci bez nadzoru!

**(FR)** Ne laissez pas les enfants sans surveillance !

**(GB)** Do not leave children unattended!

**(IT)** Non lasciare bambini incustoditi!

**(D)** Lassen Sie Kinder nicht unbeaufsichtigt!

**(NL)** Laat kinderen niet zonder toezicht!

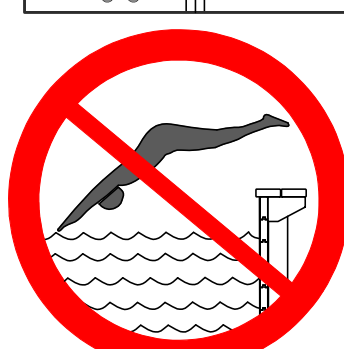
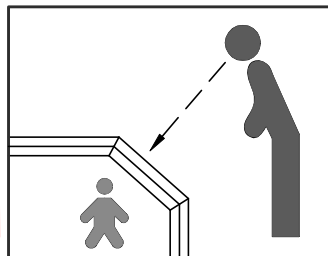

**(PL) Elementy**

**(GB) Elements**

**(D) Elemente**

**(FR) Les éléments**

**(IT) Elementi**

**(NL) Balken**



- (PL)** Sprawdź ilość oraz czy elementy nie są uszkodzone.
- (FR)** Vérifiez la quantité et si les éléments ne sont pas abîmés.
- (GB)** Check quantity of elements and if they are not faulty.
- (IT)** Controllare la quantità e se gli elementi non sono danneggiati.
- (D)** Sie die Menge, und ob die Elemente nicht beschädigt sind.
- (NL)** Controleer de aantal balken, en op eventuele beschadigingen.

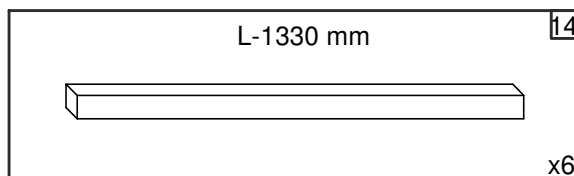
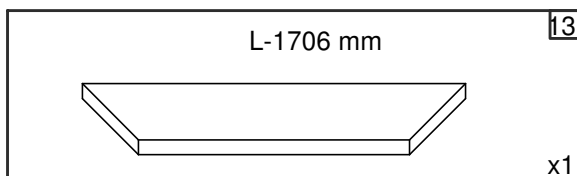
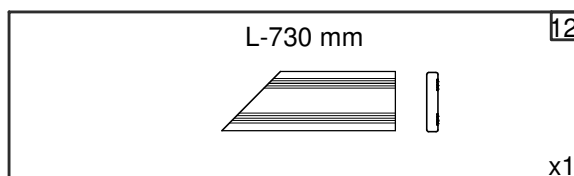
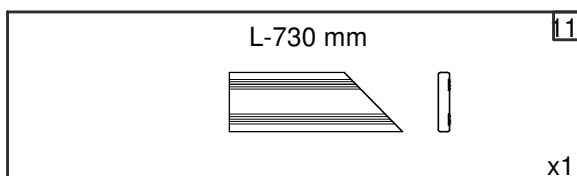
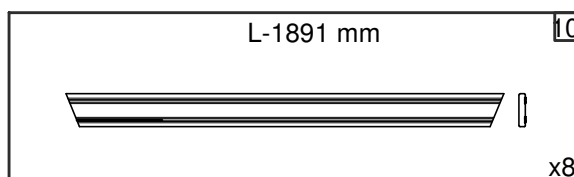
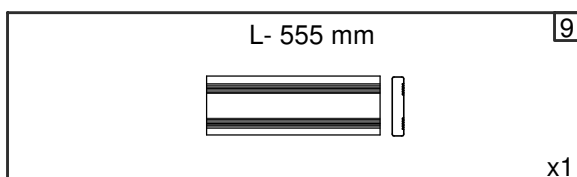
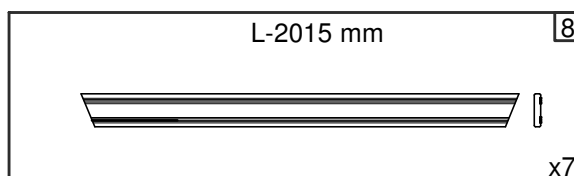
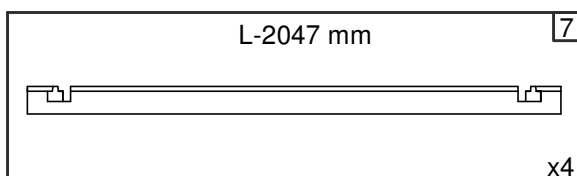
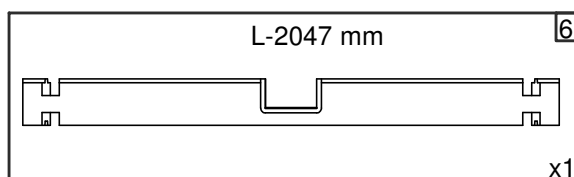
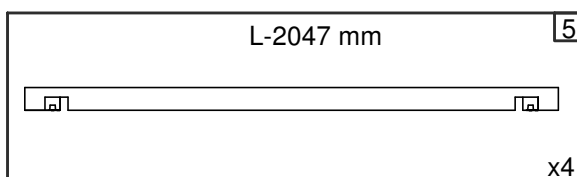
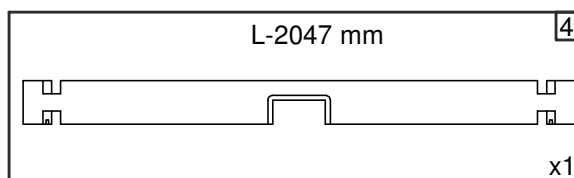
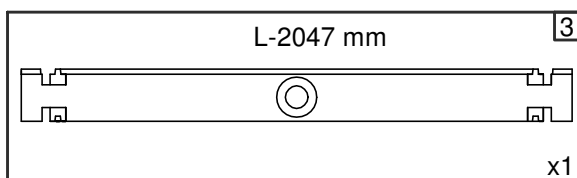
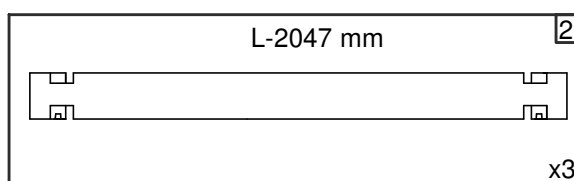
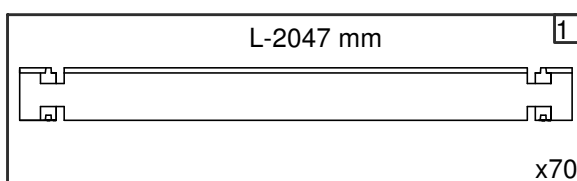
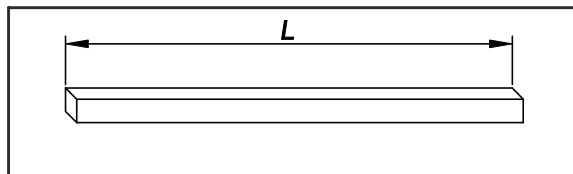

**PL** Elementy

**GB** Elements

**D** Elemente

**FR** Les éléments

**IT** Elementi

**NL** Balken



- PL** Sprawdź ilość oraz czy elementy nie są uszkodzone.
- FR** Vérifiez la quantité et si les éléments ne sont pas abîmés.
- GB** Check quantity of elements and if they are not faulty.
- IT** Controllare la quantità e se gli elementi non sono danneggiati.
- D** Sie die Menge, und ob die Elemente nicht beschädigt sind.
- NL** Controleer de aantal balken, en op eventuele beschadigingen.

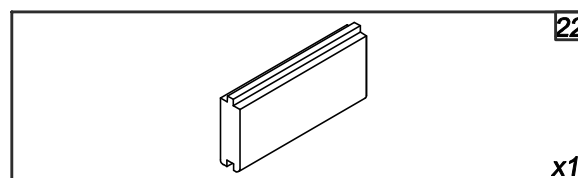
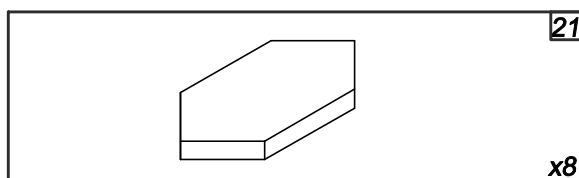
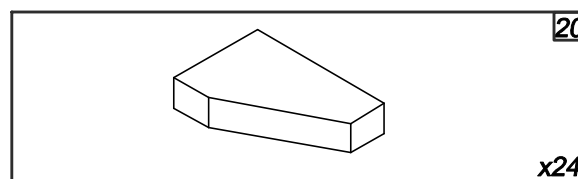
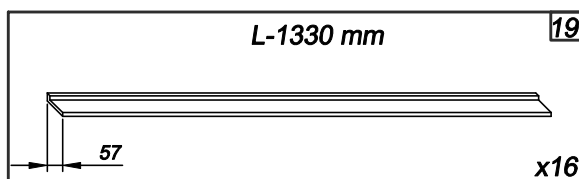
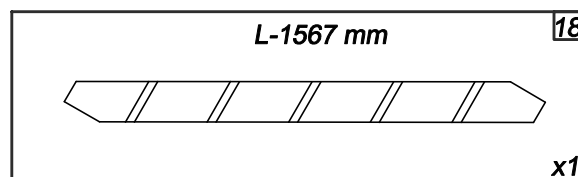
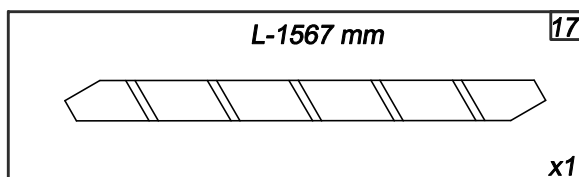
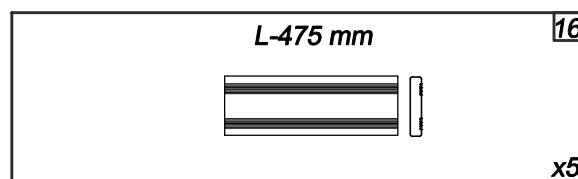
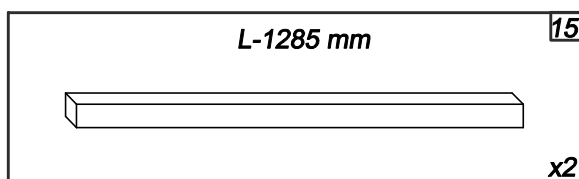
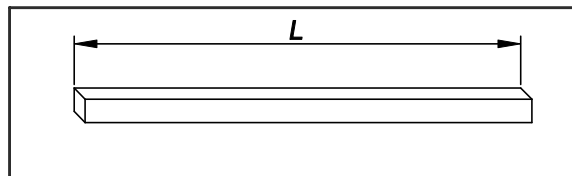

**PL** Okucia i osprzęt

**GB** Fittings and equipment

**D** Beschläge und Ausrüstung

**FR** Quincaillerie et l'équipement

**IT** Ferramenti e accessori

**NL** Bouwmaterialen



**PL** Sprawdź ilość.

**FR** Vérifiez la quantité.

**GB** Check quantity.

**IT** Controllare la quantità.

**D** Überprüfen Sie die Menge.

**NL** Controleer het aantal.

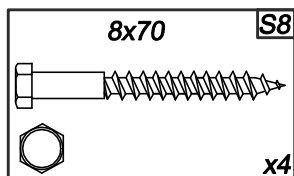
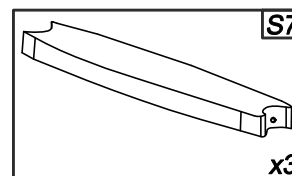
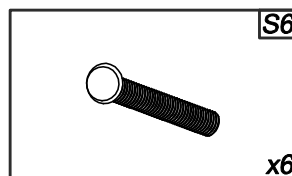
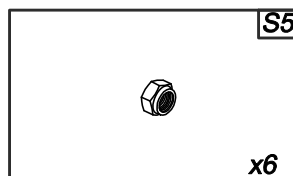
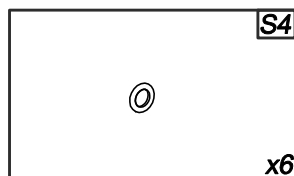
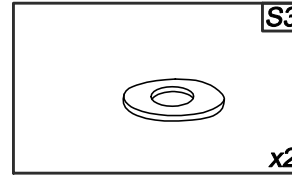
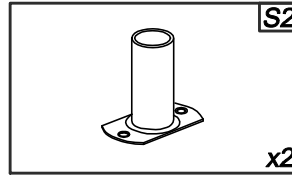
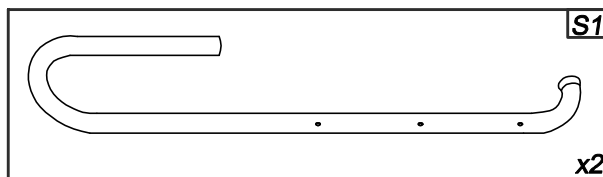
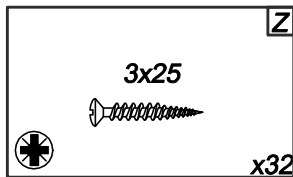
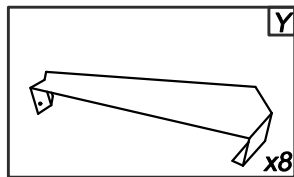
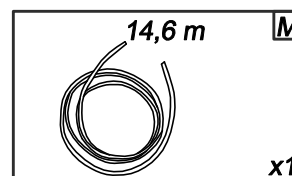
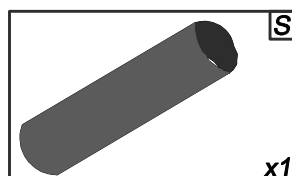
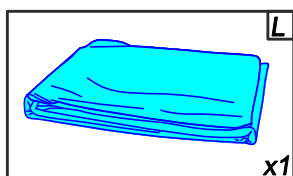
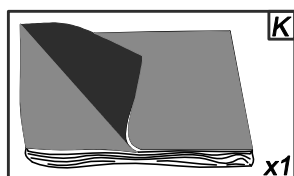
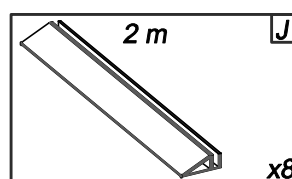
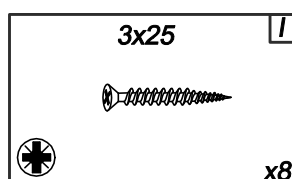
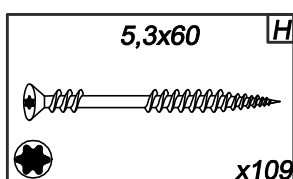
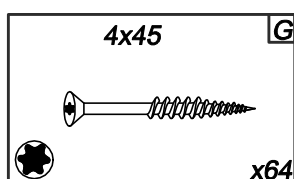
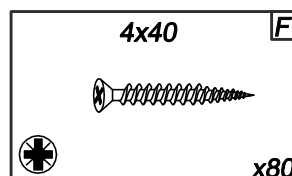
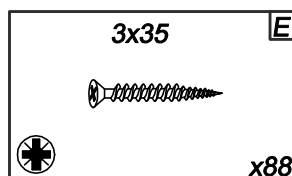
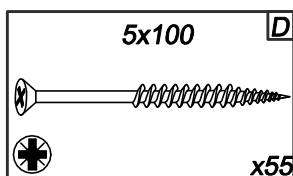
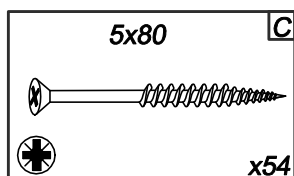
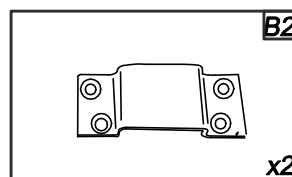
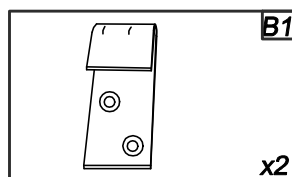
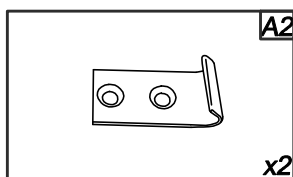
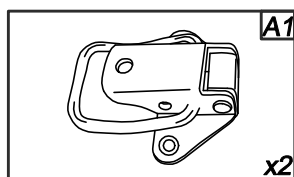

**(PL)** Skimmer i dysze

**(GB)** Skimmer and nozzles

**(D)** Skimmer und Düsen

**(FR)** Le skimmer et la buse de refoulement

**(IT)** Skimmer e ugelli

**(NL)** Skimmer en inlaat



**(PL)** Sprawdź ilość.

**(FR)** Vérifiez la quantité.

**(GB)** Check quantity.

**(IT)** Controllare la quantità.

**(D)** Überprüfen Sie die Menge.

**(NL)** Controleer het aantal.

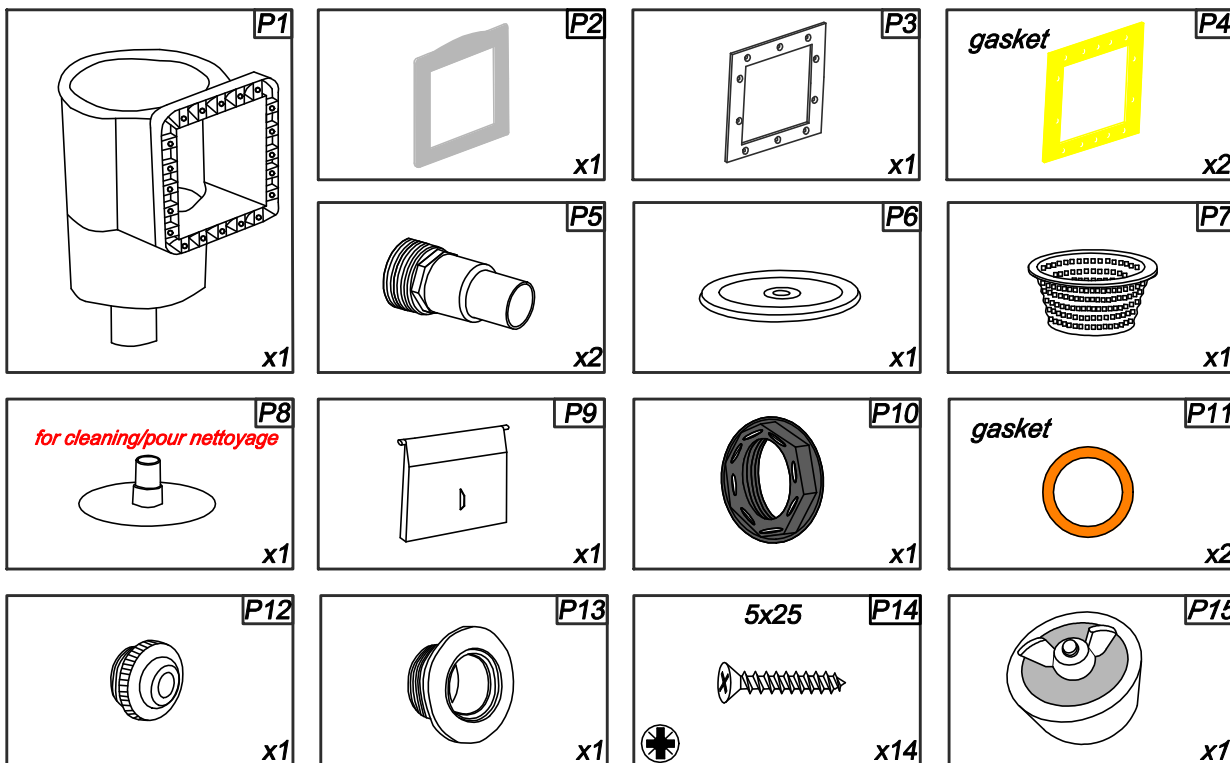

**UWAGA / ATTENTION / NOTE / ATENZIONE / HINWEIS / LETOP**

**(PL)** Poszczególne elementy osprzętu w instrukcji mogą się nieznacznie różnić od faktycznie dostarczonych.

**(FR)** Il est possible que certains éléments de l'équipement dans le notice de montage ne correspondent pas exactement à ceux fournis.

**(GB)** It is possible that some elements of equipment in the assembly instruction will not correspond exactly to those supplied

**(IT)** E possibile che degli elementi di attrezzatura nell'istruzione di riunione non corrisponderanno precisamente ad elementi approvigionati.

**(D)** Es ist möglich, dass einige Elemente der Ausrüstung in der Versammlungsanweisung genau zu gelieferten Elementen nicht entsprechen werden.

**(NL)** Het is mogelijk dat sommige onderdelen in de montage-instructies niet exact overeenkomen

**UWAGA / REMARQUE / NOTE / ATENZIONE / HINWEIS / LETOP**

**(PL)** Widok po zmontowaniu.

**(FR)** La vue après le montage.

**(GB)** After installation.

**(IT)** Vista dopo il montaggio.

**(D)** Sicht nach der Montage

**(NL)** Na installatie

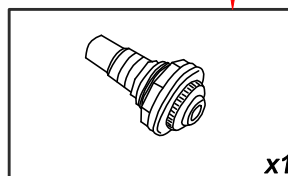
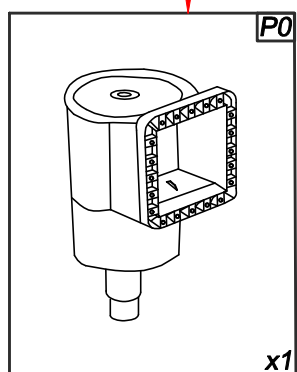

(PL) Opcja

(GB) Option

(NL) Optie

(FR) Opzione

(DE) Option



(PL) **Zatyczka do dyszy – w celu przygotowania basenu do sezonu zimowego (w szczególności przy ryzyku zamarznięcia wody), zastosuj zatyczkę do dysz napływowych, odcinając dopływ wody do zestawu filtracyjnego. Pozostaw dyszę w basenie, zamontuj zatyczkę pod wodą. Należy pamiętać również o odłączeniu zestawu filtracyjnego od źródła wody i dokładnym osuszeniu dyszy od strony zewnętrznej. Zaleca się także, aby z pompy jak i dołączonego filtra piaskowego na okres zimy (miejsca gdzie występują mrozy) usunąć pozostałości wody, w innym przypadku zamarzająca woda może dokonać zniszczenia całości zestawu.**

(FR) **Un bouchon pour la buse de refoulement - afin de préparer la piscine pour la saison d'hiver (en particulier dans le cas où il existe un risque de geler de l'eau), veuillez utiliser un bouchon fourni avec le skimmer qui fermera l'eau entre la piscine et le système de filtration. Veillez laisser la buse de refoulement dans la piscine, montez le bouchon sous l'eau. Il est également indispensable de débrancher le système de filtration et de l'écarter de la source d'eau, ainsi que de sécher consciencieusement la partie extérieure de la buse de refoulement. En plus, il est conseillé de vider le reste de l'eau se trouvant dans la pompe et le filtre à sable surtout pour la période des gels. L'eau qui gèle à l'intérieur du système de filtration peut causer des dégâts en le mettant en panne.**

(GB) **Rubber plug- in order to prepare a pool for a winter season (especially if there is a risk of freezing water) use a plug dedicated to inlet to shut the access of water to filtration system. Inlet must remain in a pool. Fix a plug under water. Remember to disconnect filtration set from source of water and dry the inlet (the part of inlet which is outside the pool). For winter season, it is recommended to get rid of water remaining in pump and sand filter, otherwise freezing water can cause devastation of whole set.**

(DE) **Stöpsel für die Düse - den Pool für die Wintersaison vorbereiten (insbesondere wegen der Gefahr des einfrierenden Wassers), verwenden Sie dazu die Zufusssdüse. Schneiden Sie die Wasserzufuhr zu dem Filtersystem ab, nachdem Sie den Filter abgetrennt haben, sollten Sie auf die gründliche Trocknung der Düse von außen achten, und dass die Filteranlage von der Wasserquelle abgetrennt ist. Lassen Sie die Düse in den Pool, installieren Sie den Stöpsel unter dem Wasser. Es wird auch empfohlen, aus dem Sandfilter sowie der Pumpe restliches Wasser zu entfernen (Stellen wo Frost entstehen kann), da sonst das gefrierende Wasser das komplette Filtersystem beschädigt.**

(NL) **Rubber plug - om het zwembad winterklaar te maken (zeker als er kans is op bevroering) dient u de plug in de inspuiter te plaatsen om zo de watertoevoer naar het filtersysteem af te sluiten. De inspuiter moet in het zwembad blijven; de plug komt onder water. Denk er aan de filterset los te koppelen van het bad en maak de inspuiter droog (het gedeelte aan de buitenkant van het bad). Gedurende het winterseizoen wordt aanbevolen het restwater uit de pomp en de zandfilter te verwijderen om kapotvriezen van de complete installatie te voorkomen.**

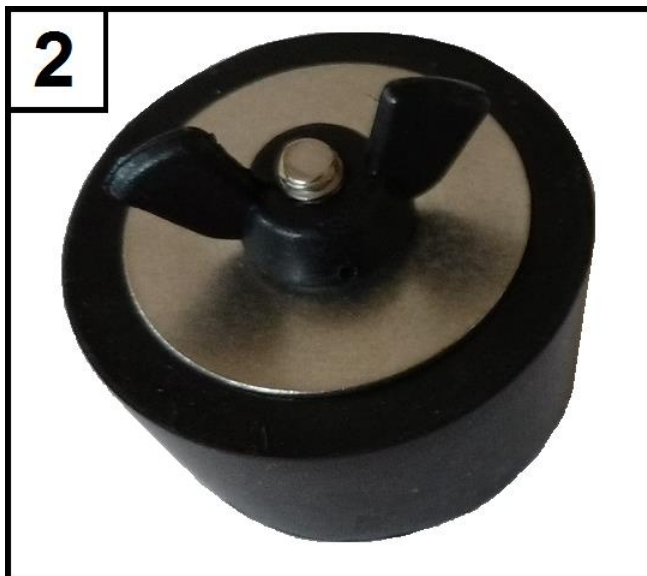
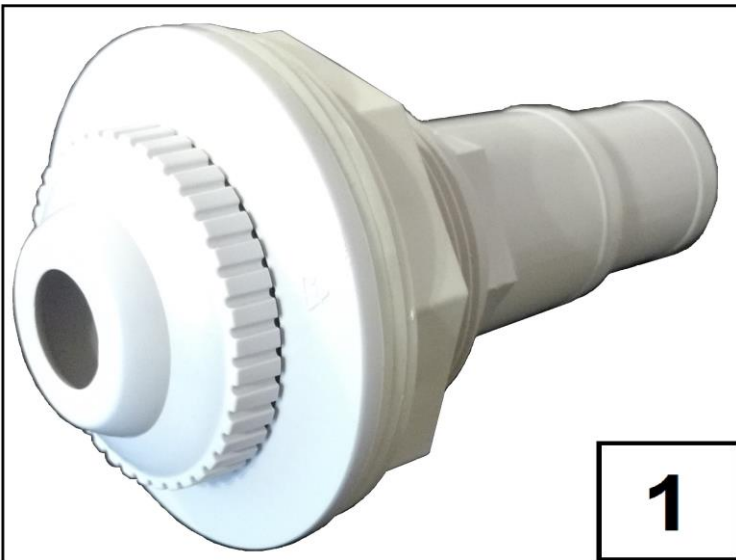



**PL** Narzędzia

**GB** Tools

**D** Werkzeuge

**FR** Les outils

**IT** Strumenti

**NL** Gereedschap

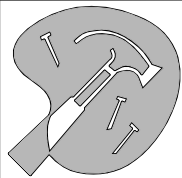

**PL** Przygotuj niezbędne narzędzia - niezawarte w zestawie.

**FR** Préparez les outils nécessaires - pas inclus.

**GB** Prepare essential tools- not included.

**IT** Preparare gli strumenti necessari - non inclusi nel set.

**D** Bereiten Sie notwendiges, nicht im Satz enthaltenes Werkzeug vor.

**NL** Benodigd gereedschap - niet inbegrepen.

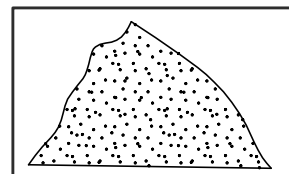
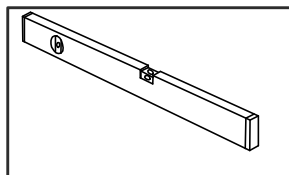
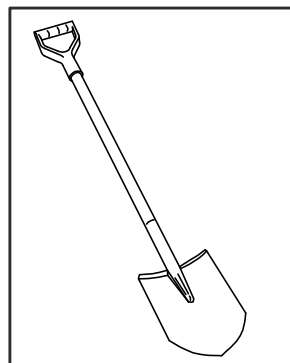
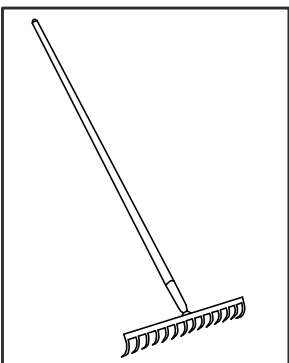
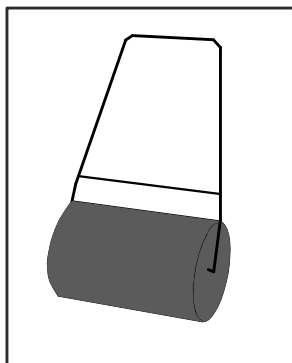
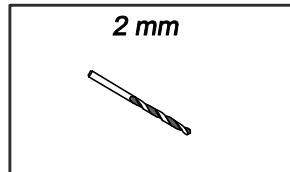
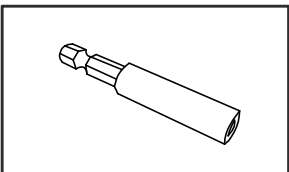
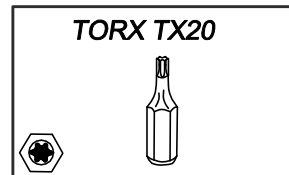
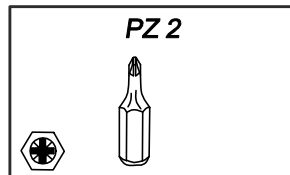
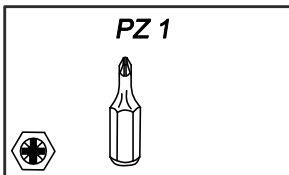
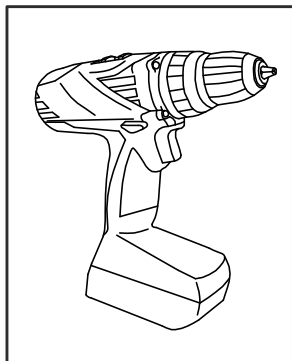
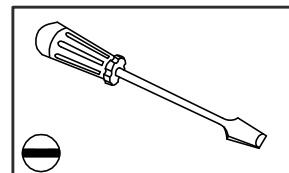
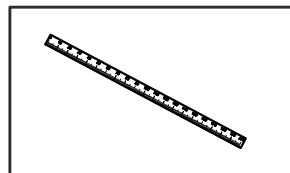
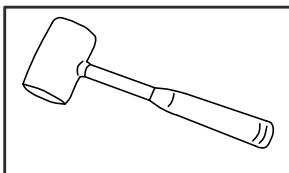
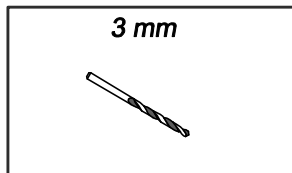
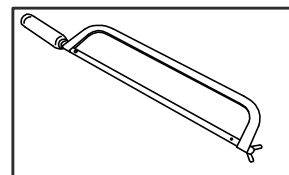
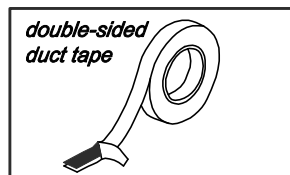
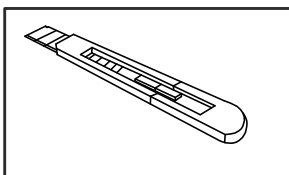
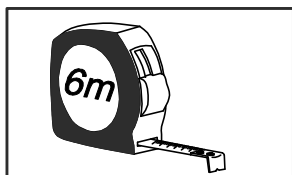
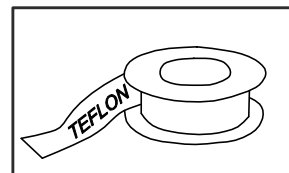
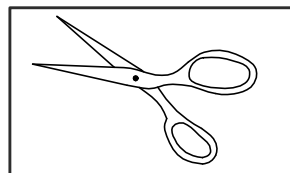
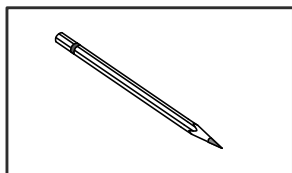

**(PL) Podłoże**

**(GB) Ground**

**(D) Untergrund**

**(FR) Terrain**

**(IT) Suolo**

**(NL) Ondergrond**



- (PL)** Struktura basenu wkopanego musi być zabezpieczona zgodnie z dołączoną dodatkowo dokumentacją.  
**(FR)** Il est exigé que la structure de la piscine enterrée soit convenablement protégée selon les indices dans le document supplémentaire ci-joint.  
**(GB)** Structure of in-ground pool must be secured in accordance with additional enclosed documentation.  
**(IT)** È esatto che la struttura della piscina seppellita sia protetta correttamente in allegato secondo gli indizi nel documento supplementare.  
**(D)** Die Struktur des Pools, der ausgegraben wird, muss gesichert werden, gemäß information in der Begleitdokumentation.  
**(NL)** De constructie van het ingebouwde zwembad moet beschermd worden volgens de instructies in bijgaande documentatie.

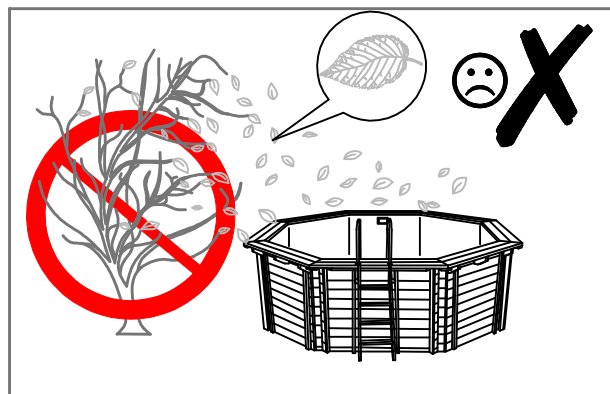
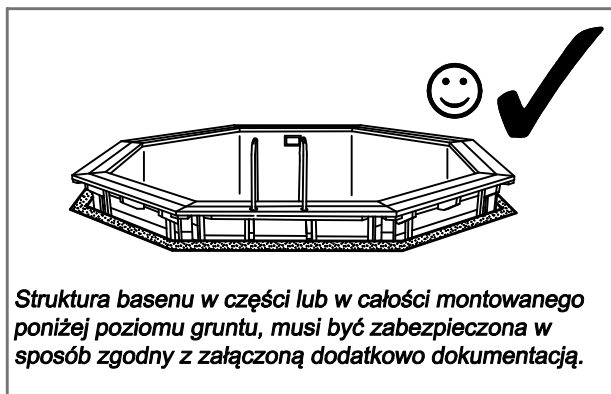
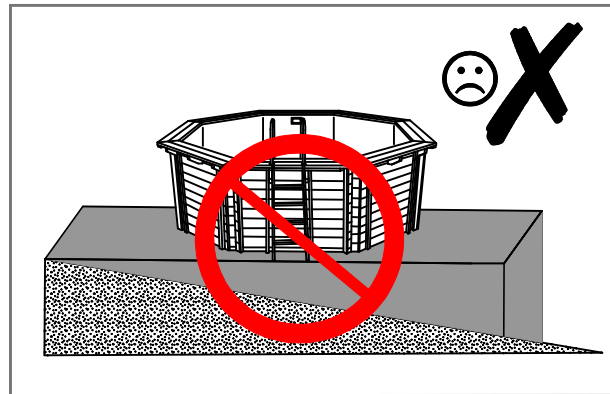
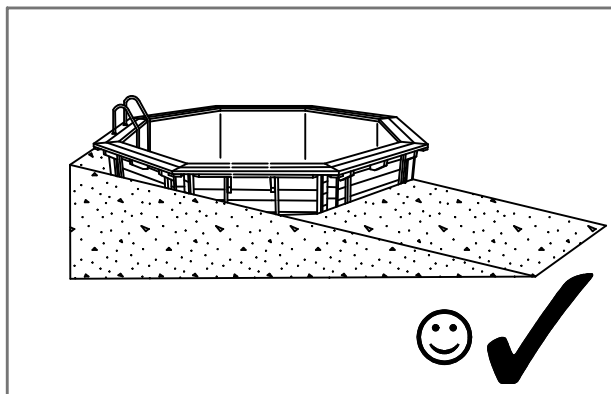
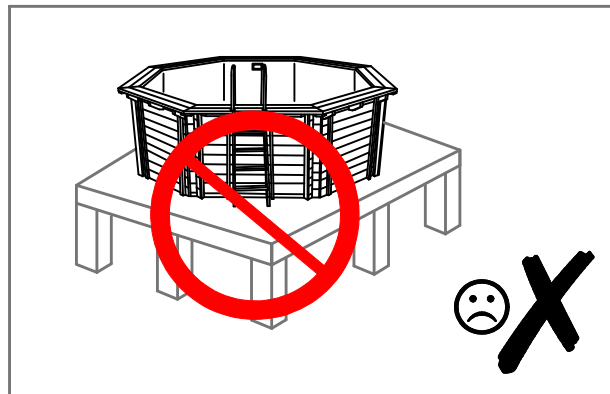
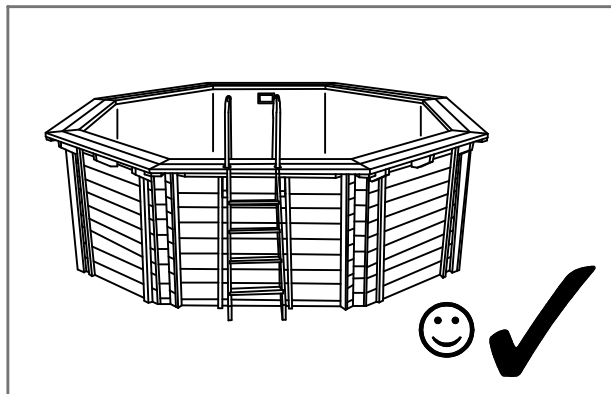

**(PL)**

Struktura basenu w części lub w całości montowanego poniżej poziomu gruntu, musi być zabezpieczona w sposób zgodny z załączoną dodatkowo dokumentacją.

**(FR)**

Il est exigé que la structure de la piscine enterrée ou semi-enterrée soit convenablement protégée selon les indices dans le document supplémentaire ci-joint.

**(GB)**

Structure of partly or fully in-ground pool, must be secured in accordance with additional enclosed documentation.

**(IT)**

È esatto che la struttura della piscina sepolta o semi-sepolta sia protetta correttamente in allegato secondo gli indizi nel documento supplementare.

**(D)**

Die Struktur des Pools, die teilweise oder vollständig unter der Erdoberfläche montiert ist, muss gemäß der beiliegenden Dokumentation gesichert werden.

**(NL)**

De constructie van het half- of volledig ingebouwde zwembad moet beschermd worden volgens de instructies in bijgaande documentatie.

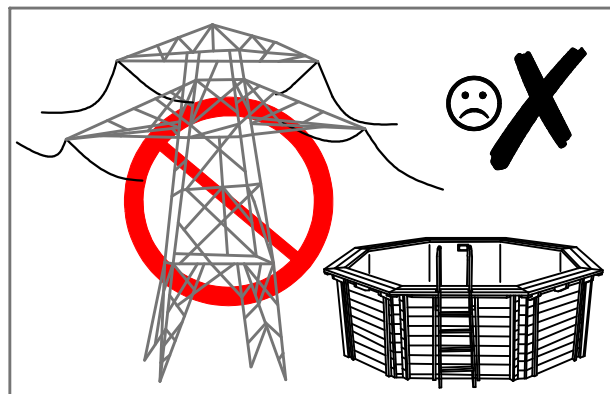

**(PL) Podłoże**

**(GB) Ground**

**(DE) Untergrund**

**(FR) Terrain**

**(IT) Suolo**

**(NL) Ondergrond**



- (PL)** Wymagane zabezpieczenie struktury przy montażu basenu poniżej poziomu gruntu.  
**(FR)** La protection de la structure dans le cas de la piscine totalement ou partiellement enterrée.  
**(GB)** Wooden structure protection required in case of in-ground installation.  
**(IT)** La protezione della struttura nel caso della piscina totalmente o parzialmente sepolta.  
**(DE)** Erforderliches Schutz für Struktur eines Holzpool, wenn es unter der Boden montieren.  
**(NL)** Bescherming van de houten constructie is absoluut noodzakelijk bij ingebouwde zwembaden.

- 1** FUNDAMENT BASENU / DALLE BETON / FOUNDATION / LASTRA CEMENTO / DAS FUNDAMENT / FUNDERING
- 2** RURA DRENARSKA / TUYAU DE DRAINAGE / DRAINAGE PIPE / TUBO DI DRENAGGIO / DIE DRAINAGEROH / AFVOERPIJP
- 3** PEÇHERZYKOWA FOLIA FUNDAMENTOWA / PROTECTION DE SOUBASSEMENT / FOINDATION BUBBLE WRAP / FONDALINE / DAS FUNDAMENT NOPPENFOLIE / BOUWFOLIE
- 4** ŻWIR / GRAVIER / GRAVEL / GHIAIA / DER KIES / GRAVEL
- 5** GEOWŁÓKNINA OGRODOWA / GEOTEXTILE / GEOTEXTILE / GEOTESSILI / GARTEN GEOTEXTILE / GEOTEXTEL
- 6** GRUNT / TERRAIN / GROUND / TERRENO / DER BODEN / BODEM

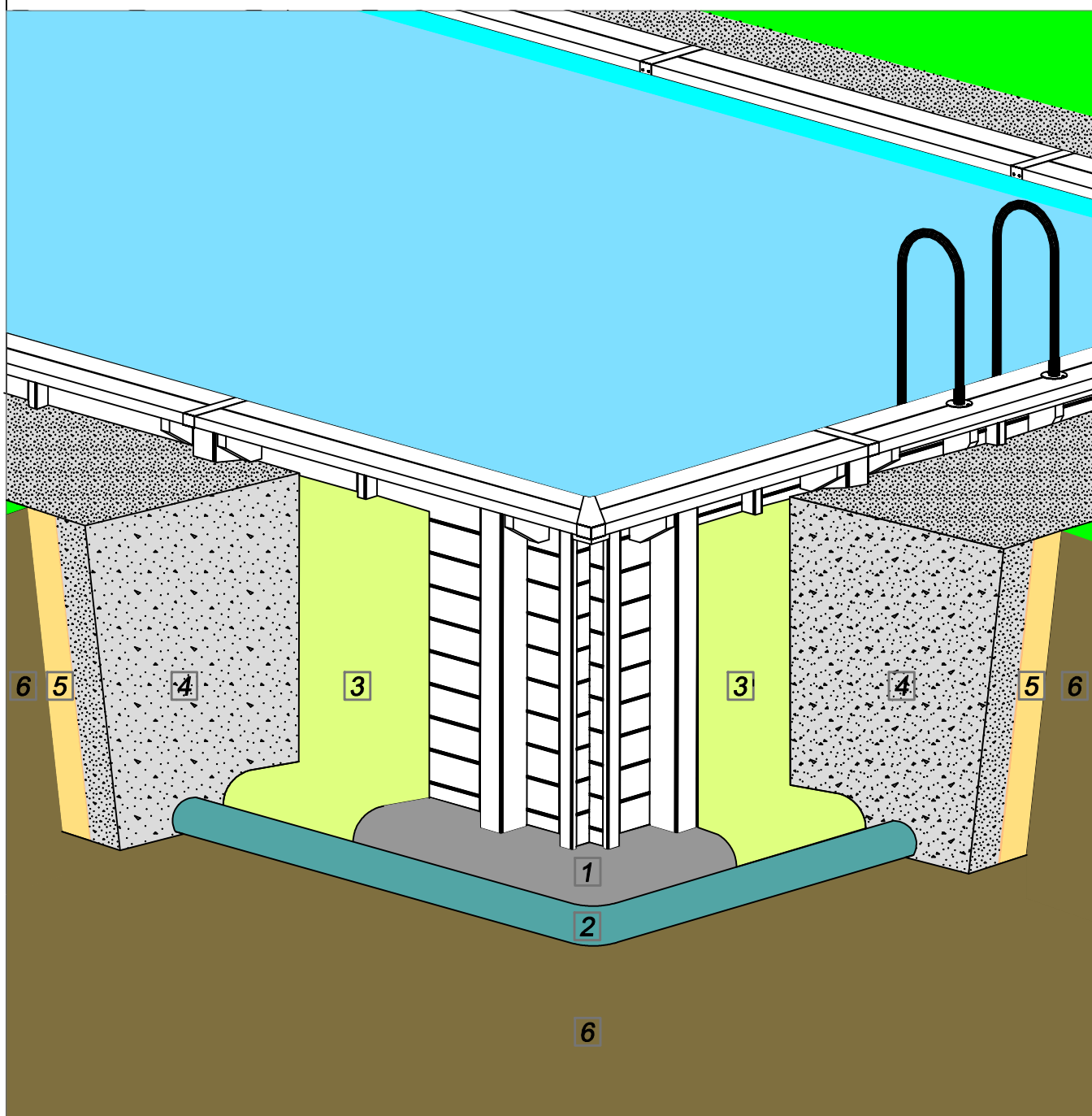

**(PL) Podłoże**

**(GB) Ground**

**(D) Untergrund**

**(FR) Terrain**

**(IT) Suolo**

**(NL) Ondergrond**



**(PL)** Ukłóź pierwszą warstwę w celu wyznaczenia terenu pod basen.

**(FR)** Posez la première couche afin de marquer le terrain sous la piscine.

**(GB)** Lay first layer to determine the surface for the pool.

**(IT)** Posare il primo strato al fine di determinare il terreno per la piscina.

**(D)** Legen Sie die erste Schicht zur Bestimmung des für Swimmingpool vorgesehenen Geländes auf.

**(NL)** Monteer de eerste laag balken om te bepalen waar het zwembad komt.

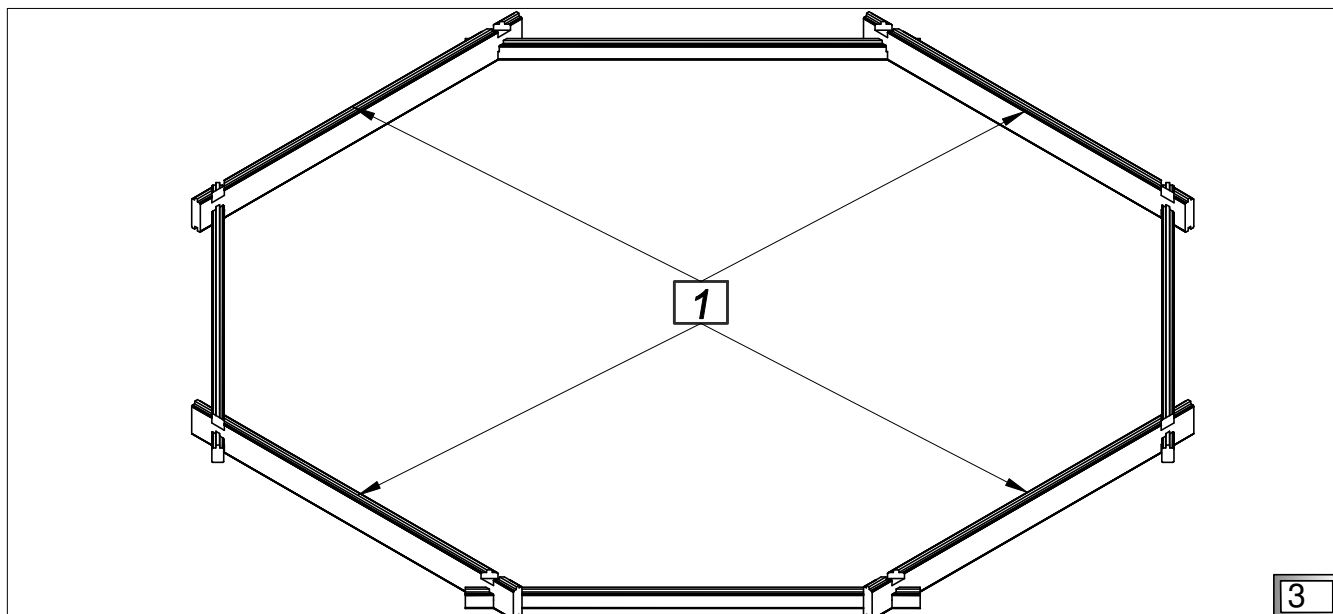
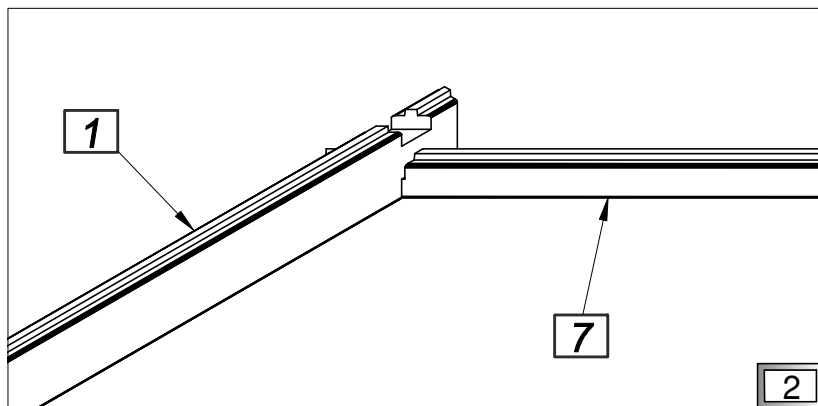
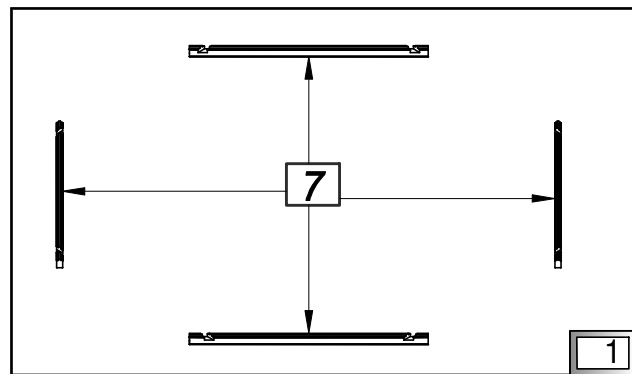
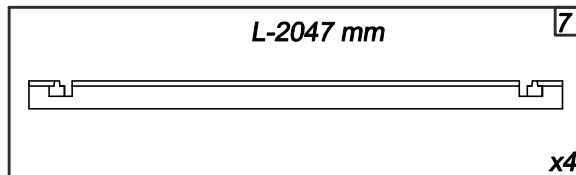
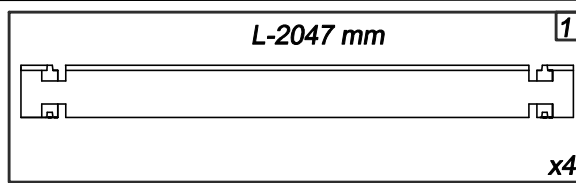
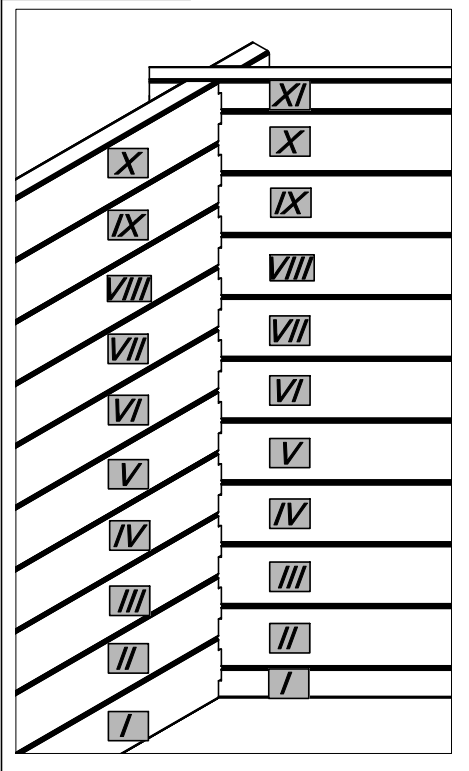

**PL** Podłoże

**GB** Ground

**D** Untergrund

**FR** Terrain

**IT** Suolo

**NL** Ondergrond



**PL** Wyznacz teren po czym rozmontuj strukturę. Usuń trawę, korzenie, kamienie.

**FR** Marquez le terrain et ensuite déplacez les éléments bois. Nettoyez bien le terrain en enlevant les herbes, les racines et les cailloux.

**GB** Mark the surface, then demount a structure. Remove grass, roots, rocks.

**IT** Determinare il terreno e poi smontare la struttura. Togliere erba, radici, pietre.

**D** Stecken Sie das Gelände auf und bauen Sie die Struktur aus. Entfernen Sie Gras, Wurzel, Steine.

**NL** Markeer de oppervlakte haal de eerst laag weg. Verwijder gras, wortels, stenen.

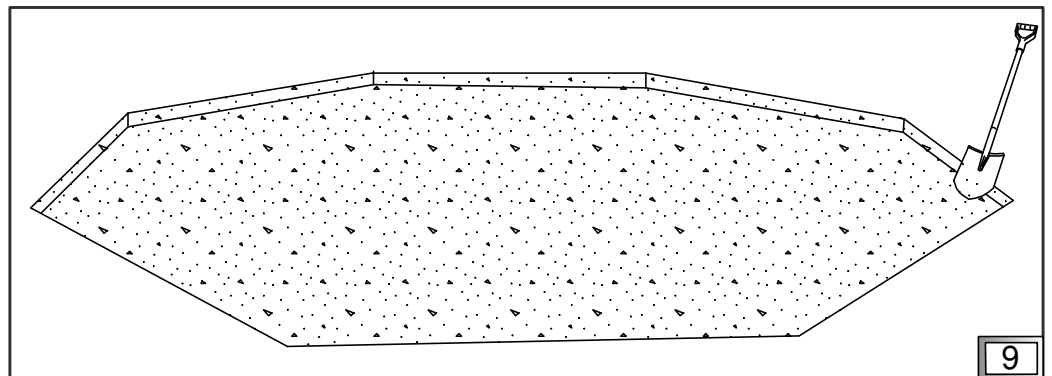
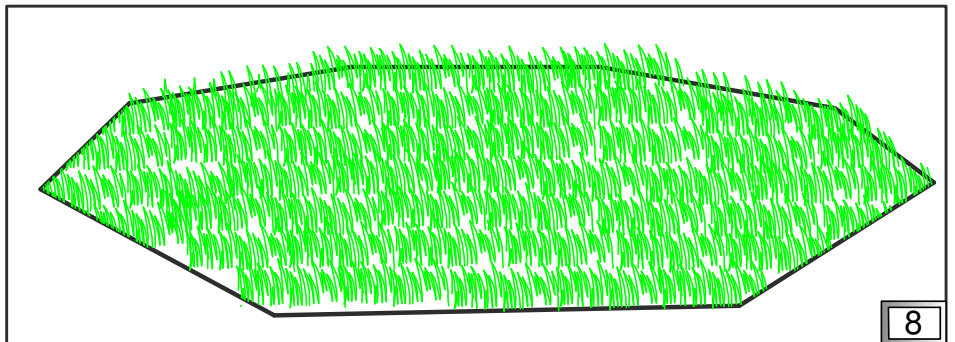
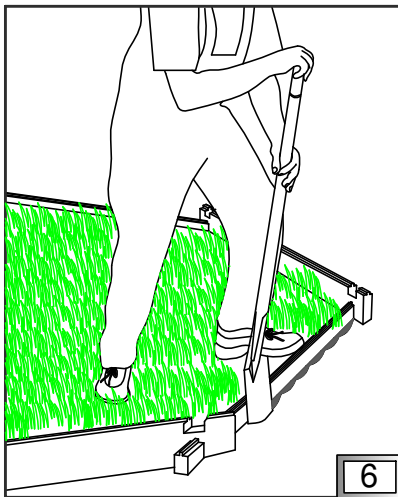
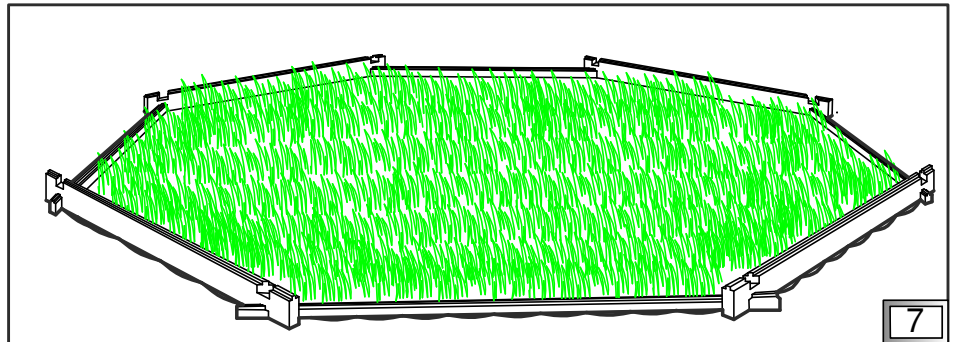
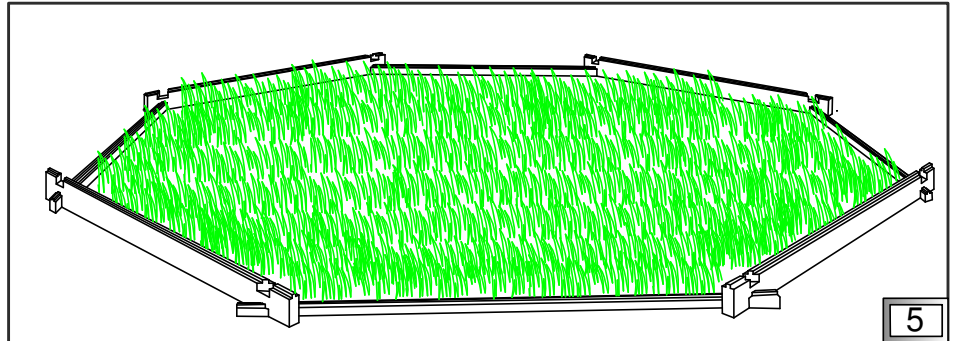
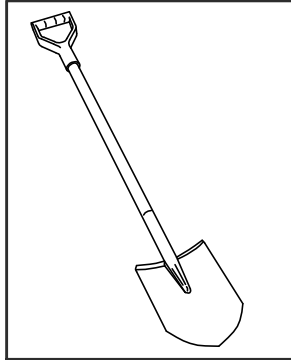

**PL** Podłoże

**GB** Ground

**D** Untergrund

**FR** Terrain

**IT** Suolo

**NL** Ondergrond



**PL** Wysyp piasek. Powierzchnia musi być twarda, płaska i wypoziomowana. Ułóż ponownie warstwę I.

**FR** Etalez du sable et refaites la couche I. Le terrain doit être rigoureusement plat, dur et de niveau.

**GB** Pour the sand. The surface must be firm, flat and leveled. Mount layer I again.

**IT** Versare sabbia. La superficie deve essere solida, piana e livellata. Posizionare di nuovo lo strato I.

**D** Schütten Sie Sand aus. Der Untergrund muss fest, flach und eben sein. Legen Sie die I-Schicht erneut auf.

**NL** Vul de ondergrond met schoon zand, de ondergrond moet stevig, vlak en waterpas zijn, monteer de eerste laag weer.

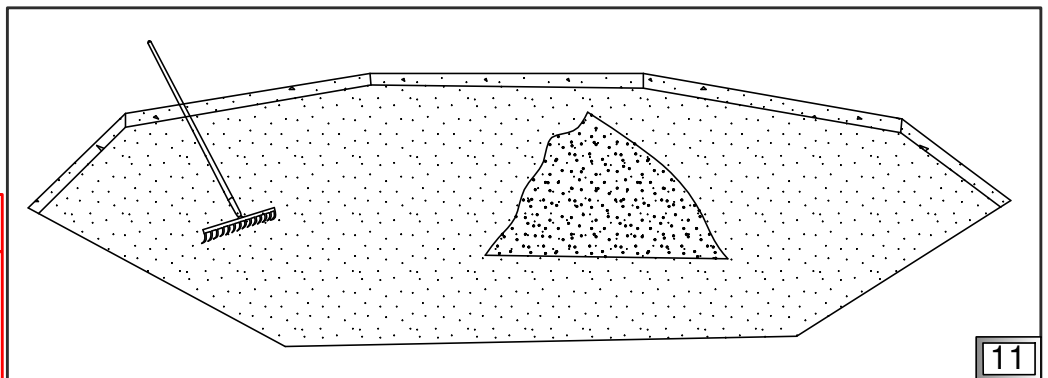
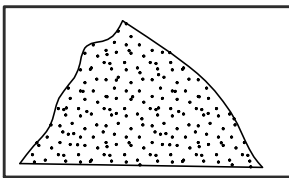
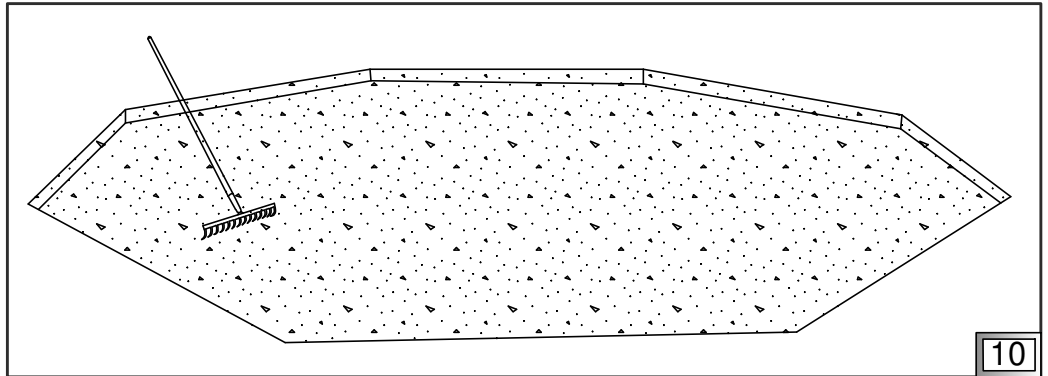
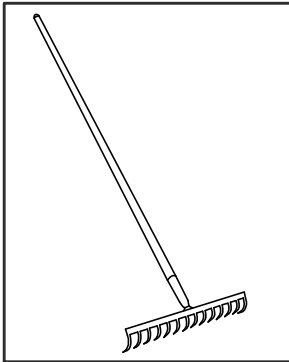

**PL** Piasek - warstwa 2 cm.  
**FR** Le sable - une couche de 2 cm.  
**GB** Sand- layer 2 cm.  
**IT** Sabbia - uno strato di 2 cm.  
**D** Sand - Schicht 2 cm.  
**NL** Zandlaag 2cm

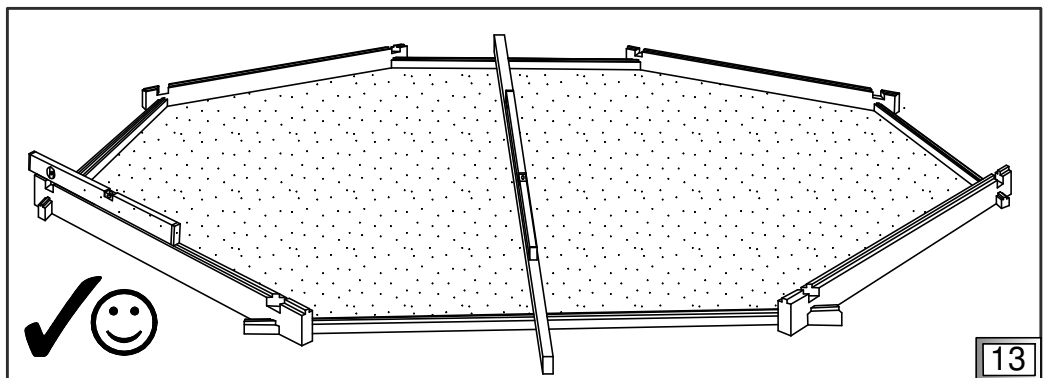
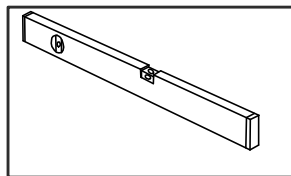
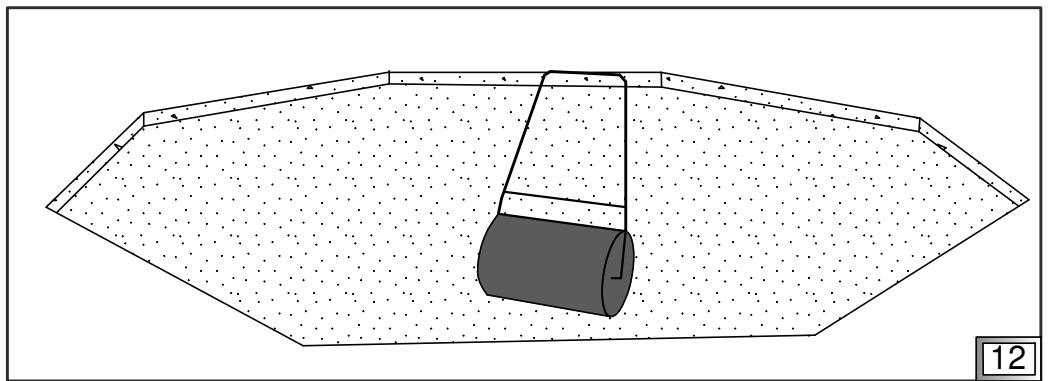
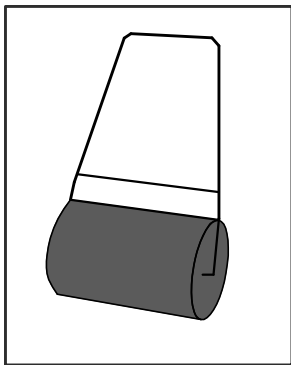

**(PL) Struktura drewniana**

**(GB) Wooden structure**

**(D) Holzstruktur**

**(FR) La structure bois**

**(IT) Struttura in legno**

**(NL) Houten structuur**



**(PL)** Po ułożeniu każdej z warstw sprawdź przekątne D według rysunku.

**(FR)** Vérifiez les diagonales "D" après la pose de chaque tour.

**(GB)** After putting each layer check D diagonals according to the drawing.

**(IT)** Dopo la posa di ogni strato bisogna controllare diagonali D, secondo il disegno.

**(D)** Nach Verlegen von jeder Schicht kontrollieren Sie D-Diagonale nach Schema.

**(NL)** Na het bouwen van de eerste laag controleer D diagonalen volgens de tekening.

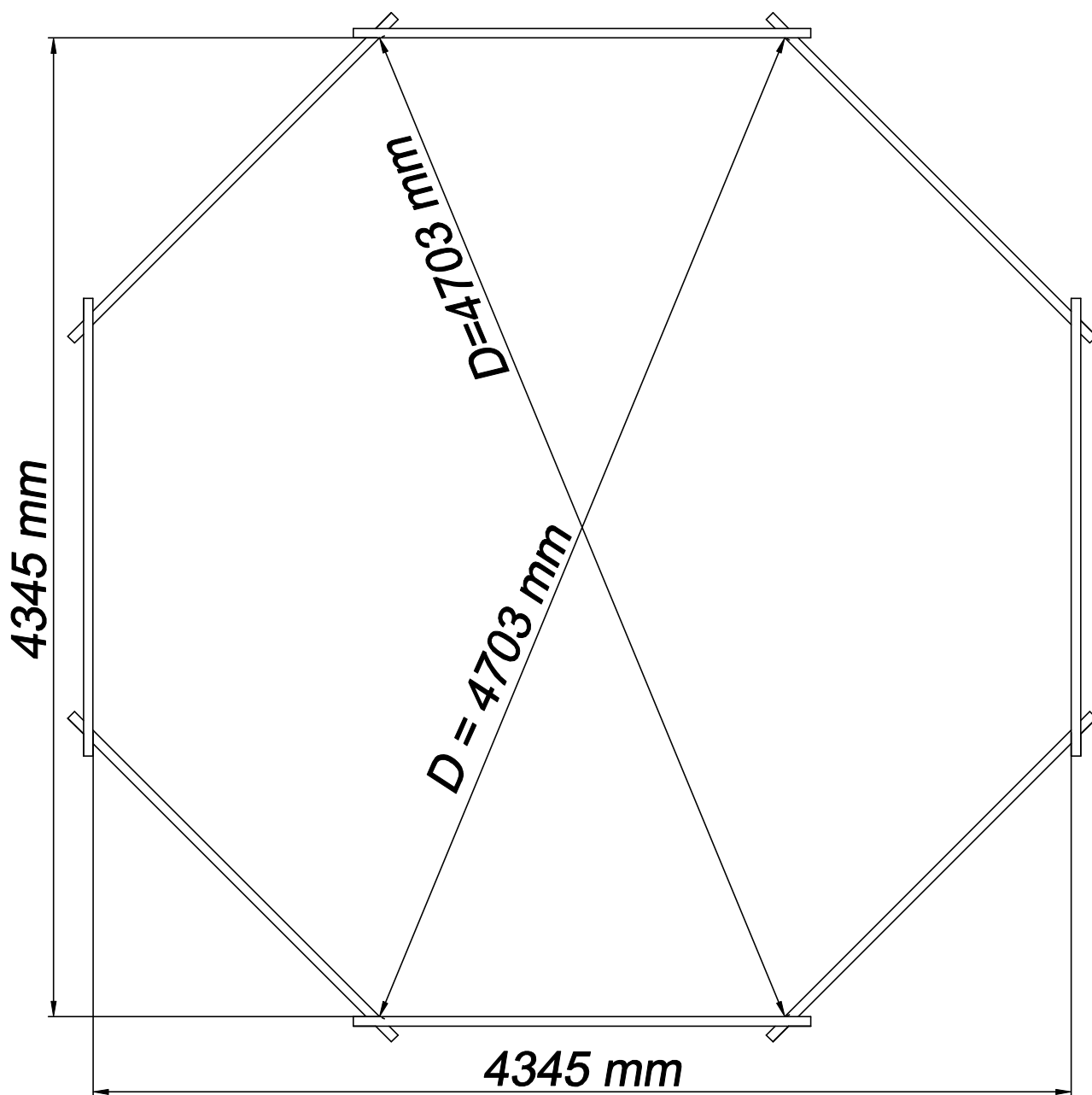
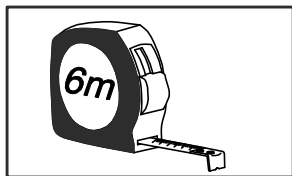

**PL** Struktura drewniana

**GB** Wooden structure

**D** Holzstruktur

**FR** La structure bois

**IT** Struttura in legno

**NL** Houten structuur



**PL** Ułożenie kolejnych warstw. Sprawdzaj przekątną D po każdej ułożonej warstwie.

**FR** L'assemblage des couches suivantes. Vérifiez les diagonales "D" après la pose de chaque tour.

**GB** Putting next layers. Check D diagonals every layer.

**IT** La messa degli strati successivi. Trova la diagonale D dopo ogni strato.

**D** Verlegen der nachfolgenden Schichten. Nach Verlegen von jeder Schicht kontrollieren Sie die D-Diagonale.

**NL** Installeer de volgende lagen en controleer diagonaal D.

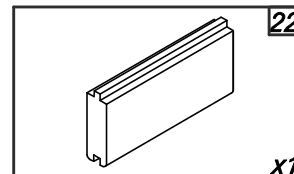
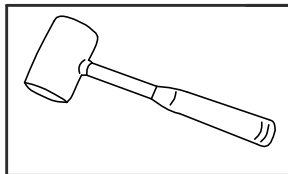
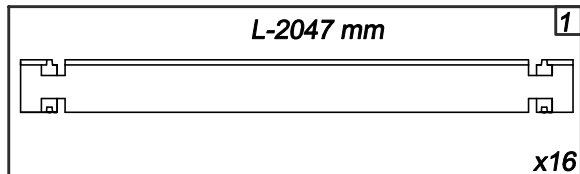

11-111

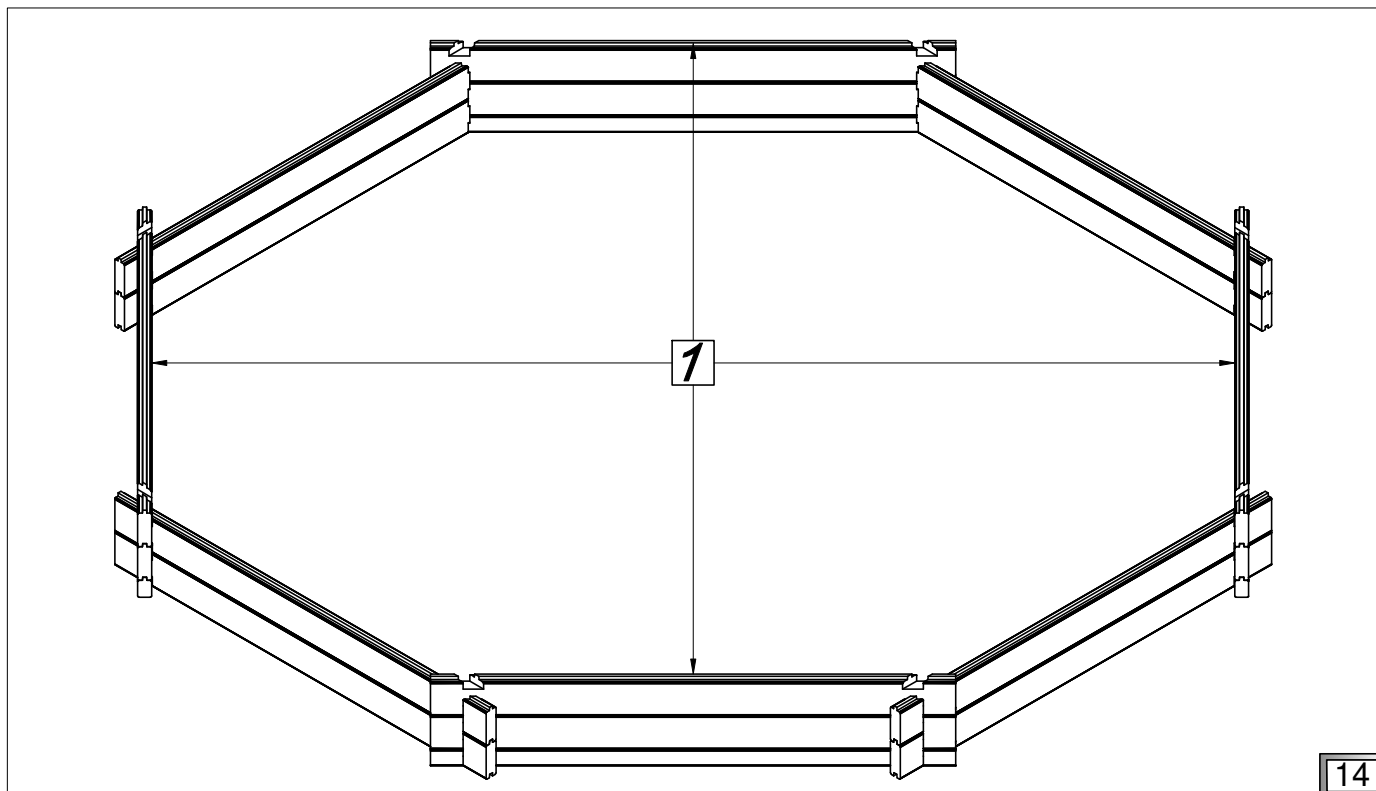

14

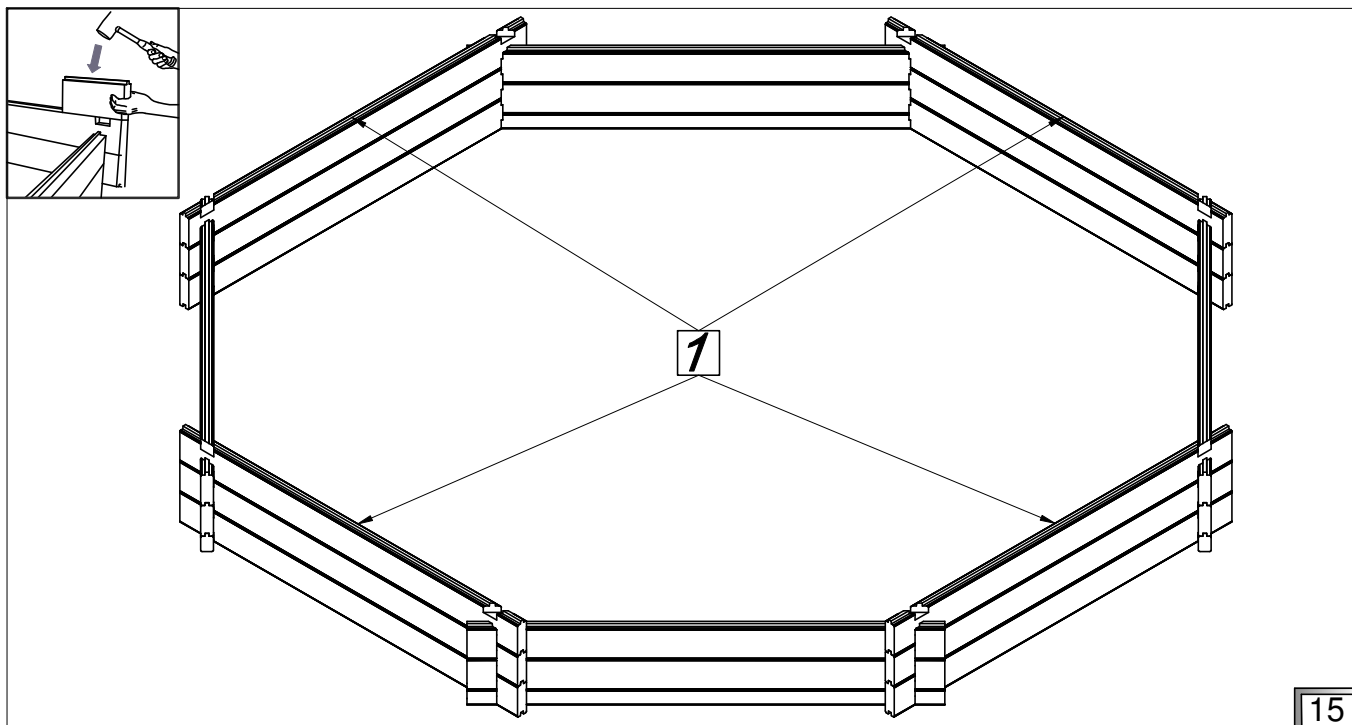
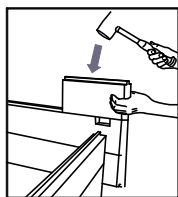

15



**(PL)** Struktura drewniana

**(GB)** Wooden structure

**(D)** Holzstruktur

**(FR)** La structure bois

**(IT)** Struttura in legno

**(NL)** Houten structuur



**(PL)** Ułożenie kolejnych warstw. Sprawdzaj przekątną D po każdej ułożonej warstwie.

**(FR)** L'assemblage des couches suivantes. Vérifiez les diagonales "D" après la pose de chaque tour.

**(GB)** Putting next layers. Check D diagonals every layer.

**(IT)** La messa degli strati successivi. Trova la diagonale D dopo ogni strato.

**(D)** Verlegen der nachfolgenden Schichten. Nach Verlegen von jeder Schicht kontrollieren Sie die D-Diagonale.

**(NL)** Installeer de volgende lagen en controleer diagonaal D.

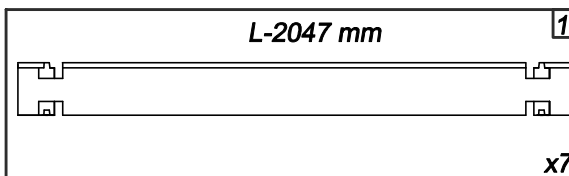
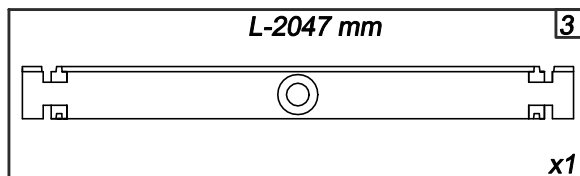

IV

**(NL)** Installeer balk nummer 3 alleen op laag 4 in gebieden waar de temperatuur niet onder nul komt, is dit wel het geval plaats dan balk nummer 3 drie lagen hoger (risico op bevriezing)

**(D)** Installieren Sie die Nr. 3 auf der Schicht 4, wo fällt die Temperatur unten 0 ° C. Anderenfalls Teil Nr. 3 installieren Schicht oben . (Risiko ganz gefroren.)

**(GB)** Install the beam no 3 on the 4th layer. If pool installed in area where temperatures fall below 0°C , install the beam no 3 on higher layer.

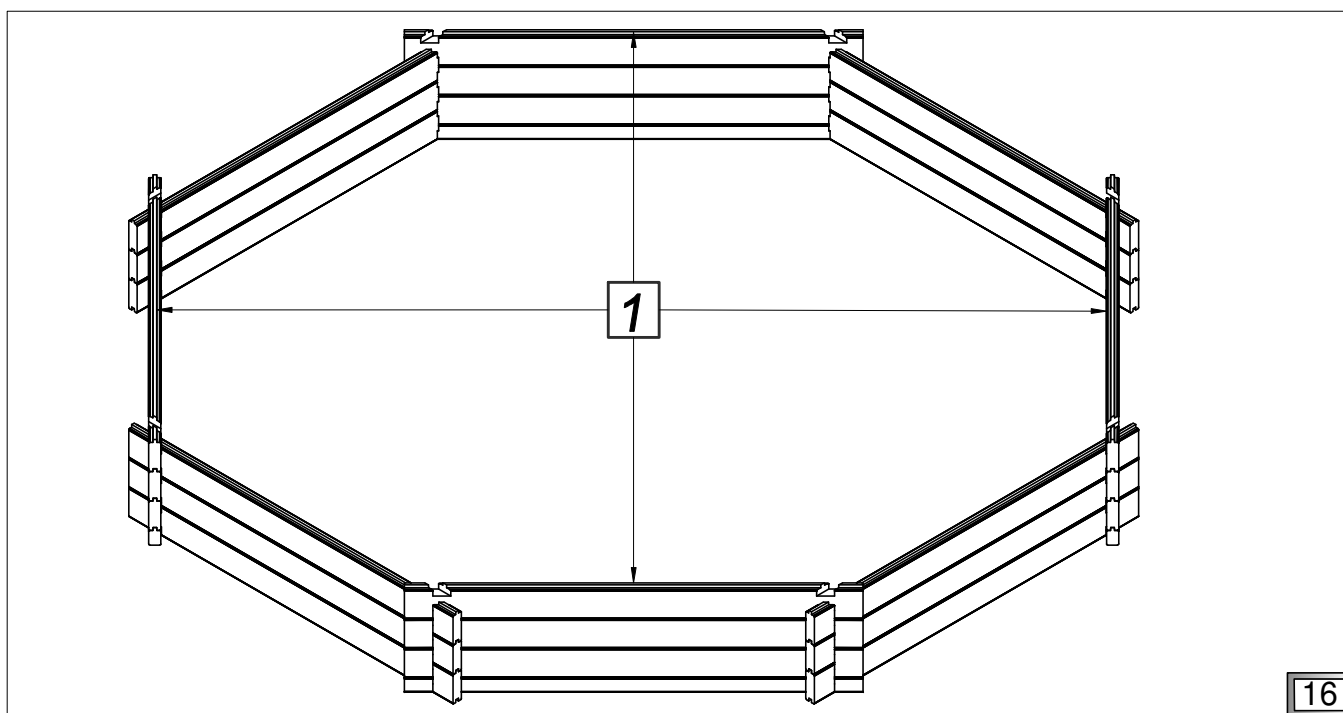

16

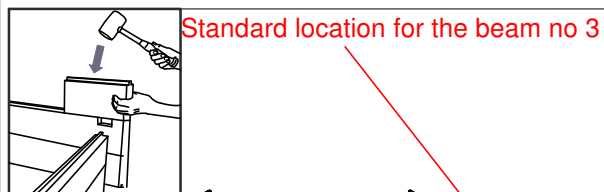

Standard location for the beam no 3

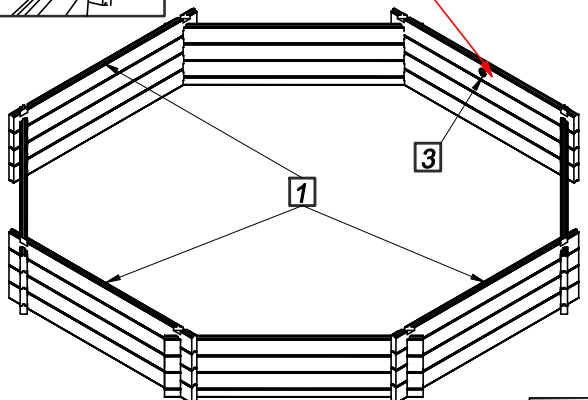

17

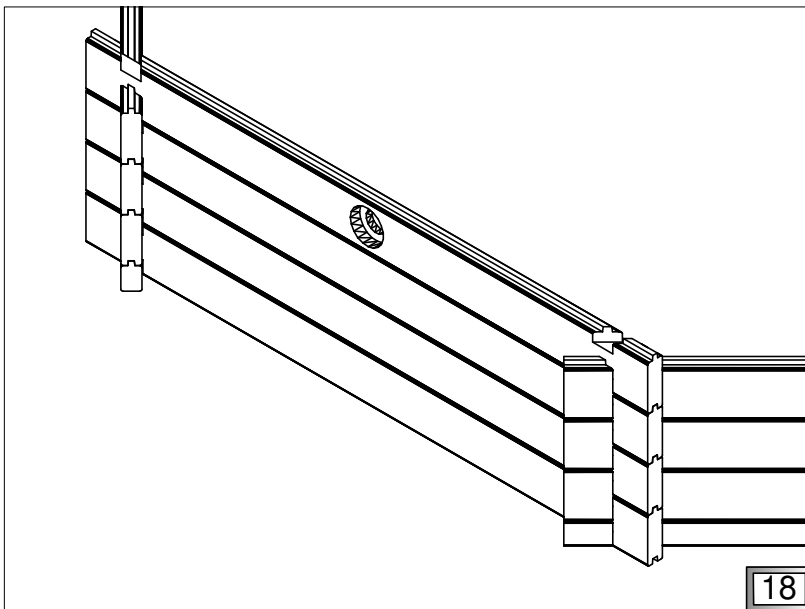

18

**(PL)** Struktura drewniana

**(GB)** Wooden structure

**(D)** Holzstruktur

**(FR)** La structure bois

**(IT)** Struttura in legno

**(NL)** Houten structuur



**(PL)** Ułożenie kolejnych warstw. Sprawdzaj przekątną D po każdej ułożonej warstwie.

**(FR)** L'assemblage des couches suivantes. Vérifiez les diagonales "D" après la pose de chaque tour.

**(GB)** Putting next layers. Check D diagonals every layer.

**(IT)** La messa degli strati successivi. Trova la diagonale D dopo ogni strato.

**(D)** Verlegen der nachfolgenden Schichten. Nach Verlegen von jeder Schicht kontrollieren Sie die D-Diagonale.

**(NL)** Installeer de volgende lagen en controleer diagonaal D.

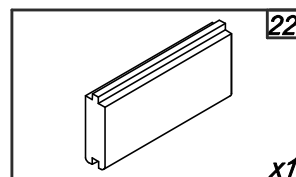
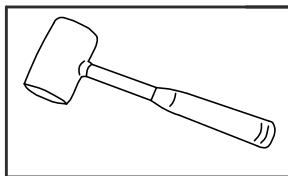
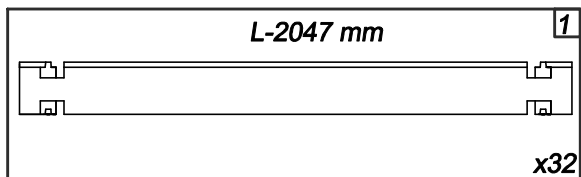

V-VIII

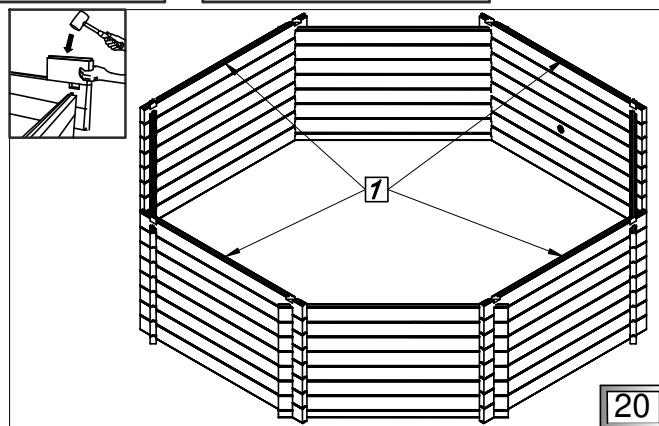
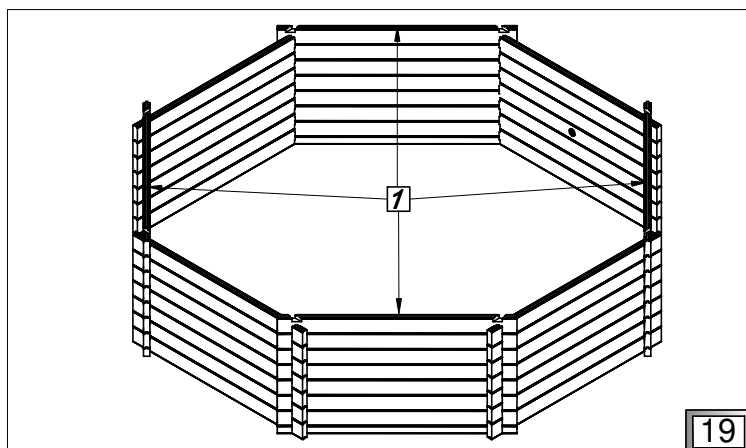

IX

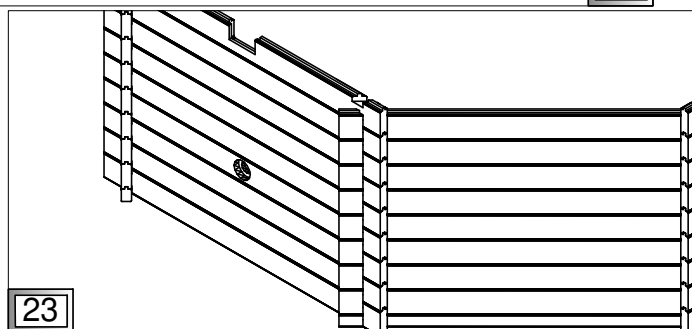
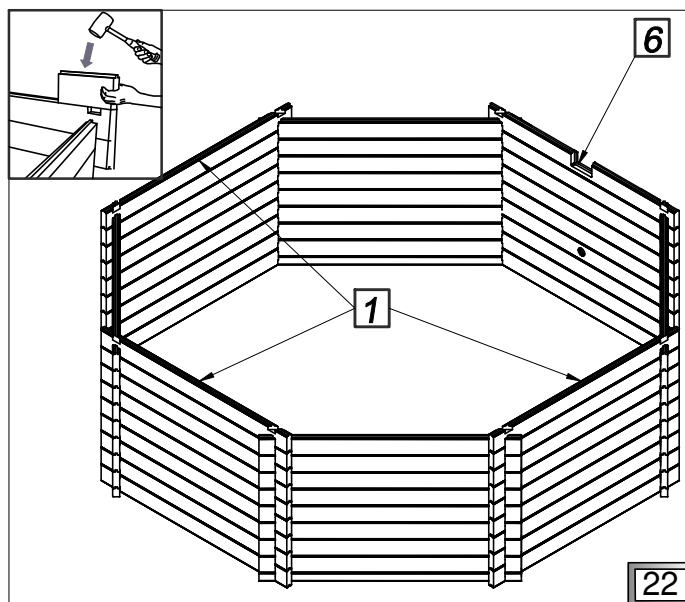
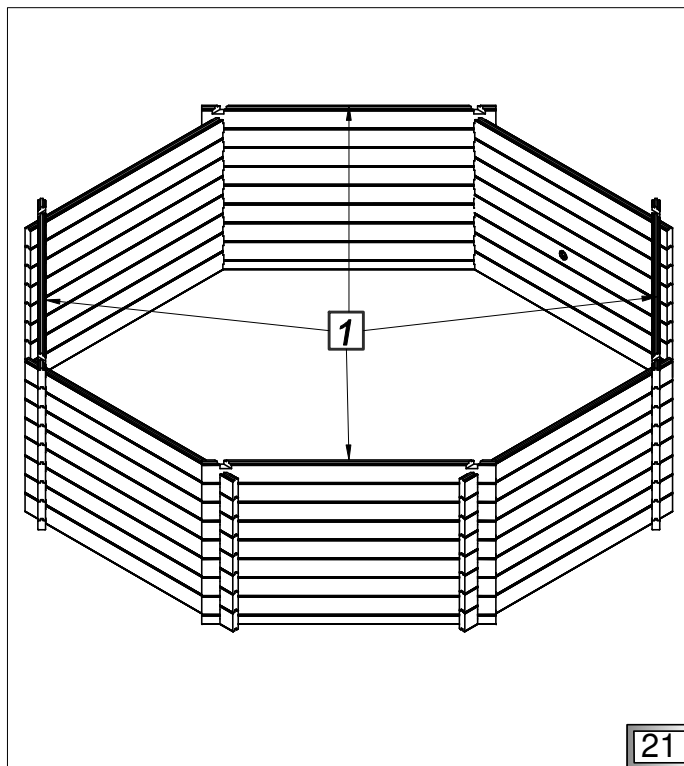
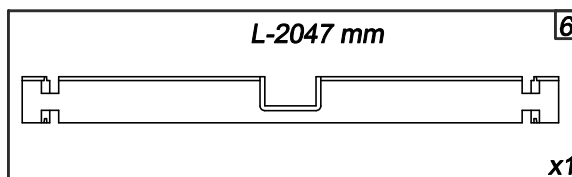
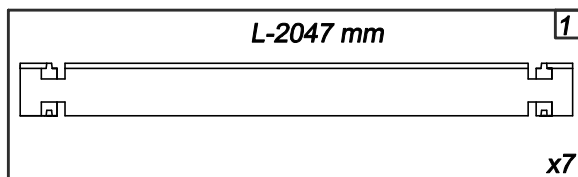

**PL** Skimmer

**GB** Skimmer

**D** Skimmer

**FR** Skimmer

**IT** Skimmer

**NL** Skimmer



**PL** Zmontuj skimmer wg rysunków. Następnie zamontuj go w strukturze.

**FR** Montez le skimmer suivant les dessins. Ensuite fixez-le à la structure.

**GB** Install a skimmer according to the drawings. Next mount it to the structure.

**IT** Montare lo skimmer secondo i disegni. Poi installarlo nella struttura.

**D** Bauen Sie den Skimmer laut den Zeichnungen ein. Anschließend montieren Sie diesen in der Struktur.

**NL** Installeer de skimmer volgens de tekeningen, vervolgens monteer de skimmer aan het houten structuur.

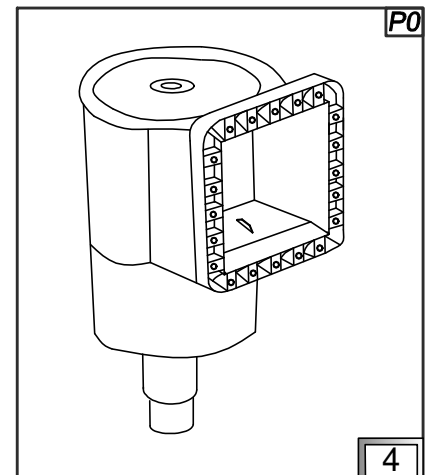
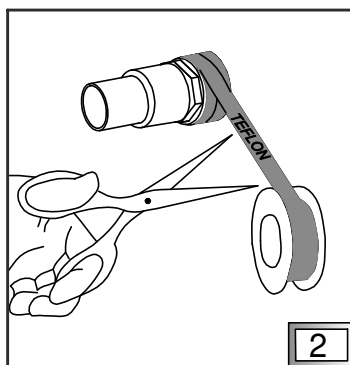
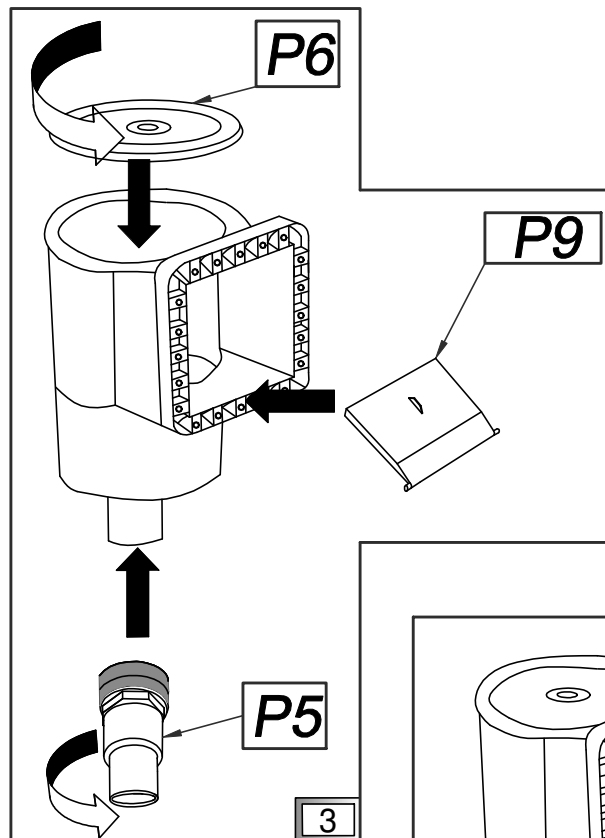
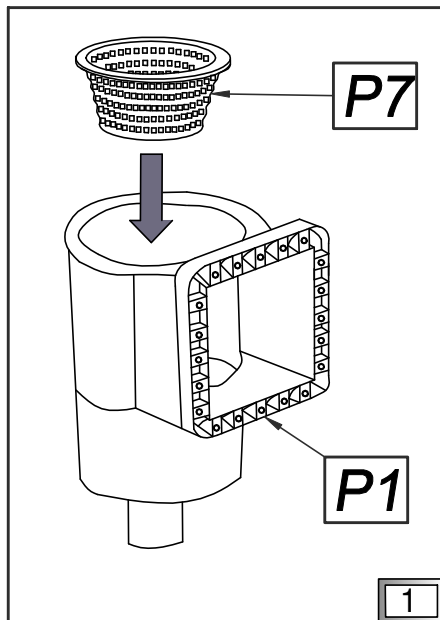
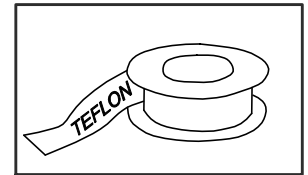
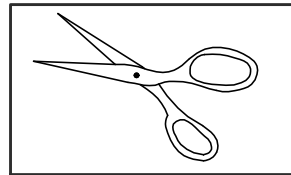
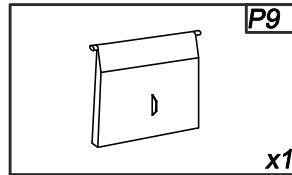
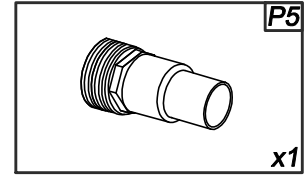
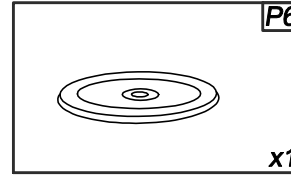
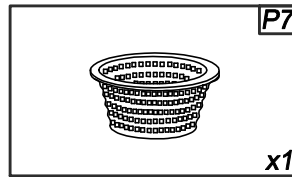
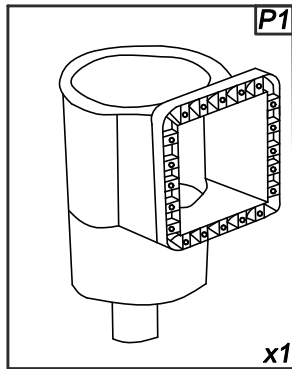

**(PL)** Struktura drewniana

**(GB)** Wooden structure

**(D)** Holzstruktur

**(FR)** La structure bois

**(IT)** Struttura in legno

**(NL)** Houten structuur



**(PL)** Ułożenie kolejnych warstw. Zamontuj skimmer (P0).

**(FR)** La pose des couches suivantes. Montez le skimmer (P0).

**(GB)** Laying next layers. Mount a skimmer (P0).

**(IT)** La disposizione degli strati successivi. Montare lo skimmer (P0).

**(D)** Auflegen der weiteren Schichten. Bauen Sie den Skimmer (P0).

**(NL)** Monteer de skimmer (P0) tussen de twee balken.

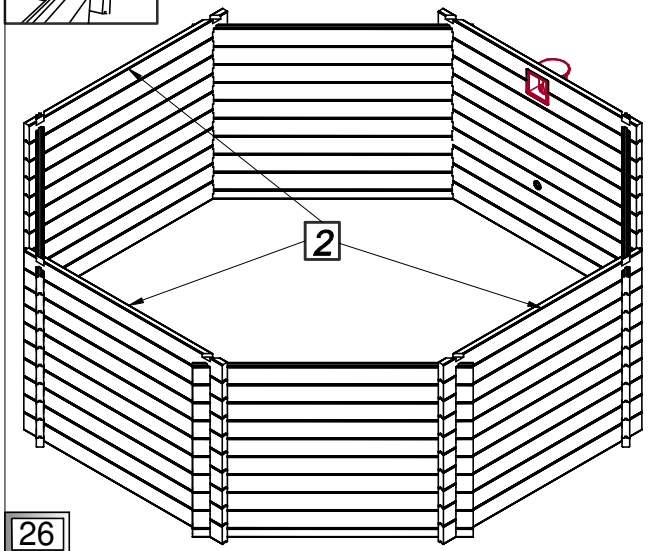
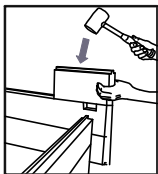
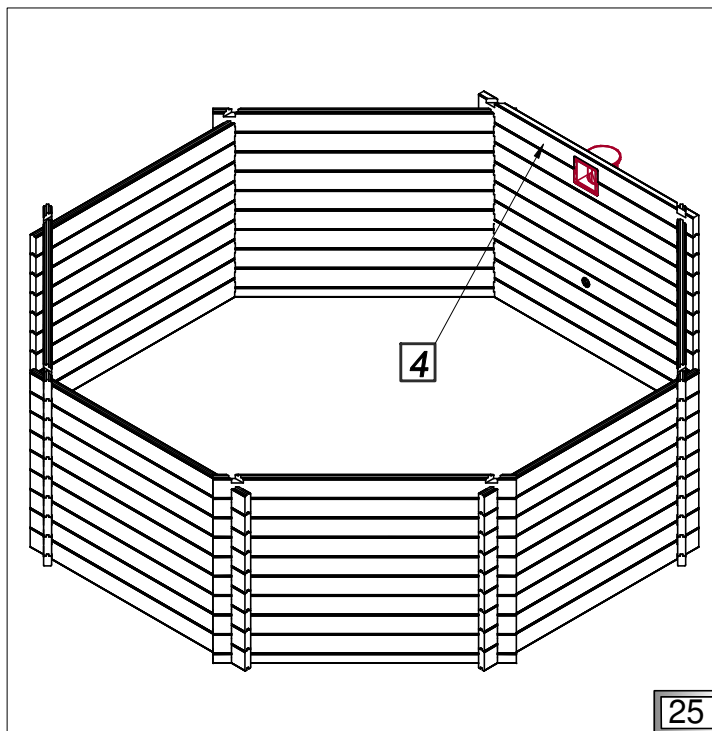
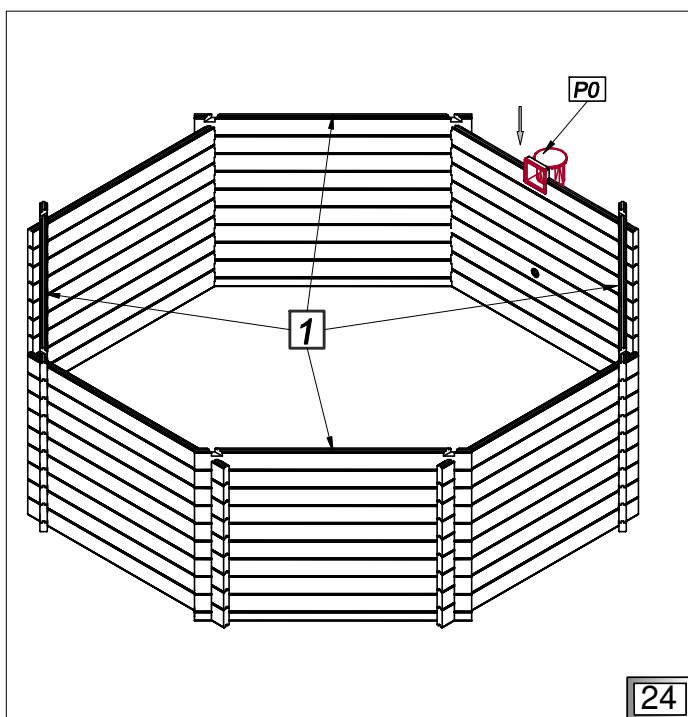
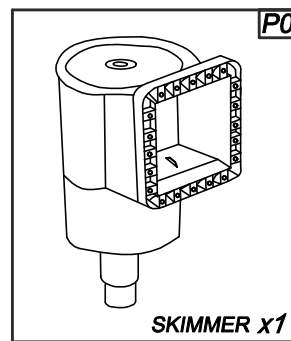
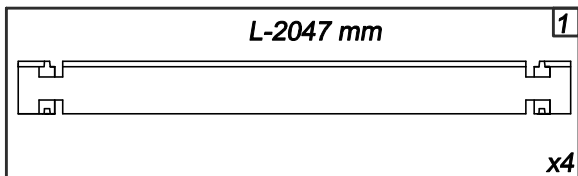
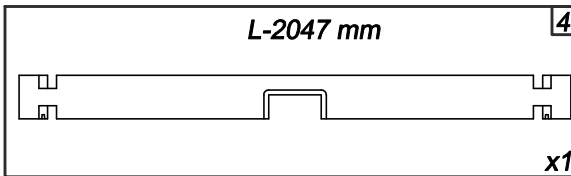
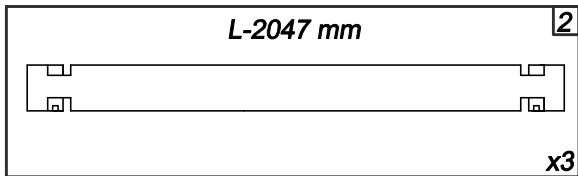

**PL** Struktura drewniana

**GB** Wooden structure

**D** Holzstruktur

**FR** La structure bois

**IT** Struttura in legno

**NL** Houten structuur



**PL** Ułożenie kolejnych warstw. Sprawdzaj przekątną D po każdej ułożonej warstwie.

**FR** L'assemblage des couches suivantes. Vérifiez les diagonales "D" après la pose de chaque tour.

**GB** Putting next layers. Check D diagonals every layer.

**IT** La messa degli strati successivi. Trova la diagonale D dopo ogni strato.

**D** Verlegen der nachfolgenden Schichten. Nach Verlegen von jeder Schicht kontrollieren Sie die D-Diagonale.

**NL** Installeer de volgende lagen en controleer diagonaal D.

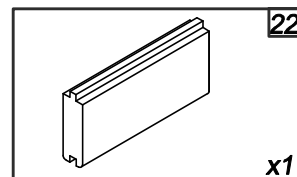
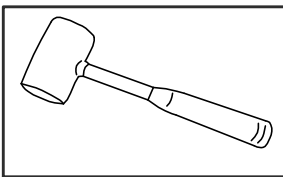
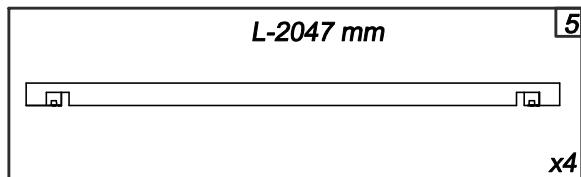

XI

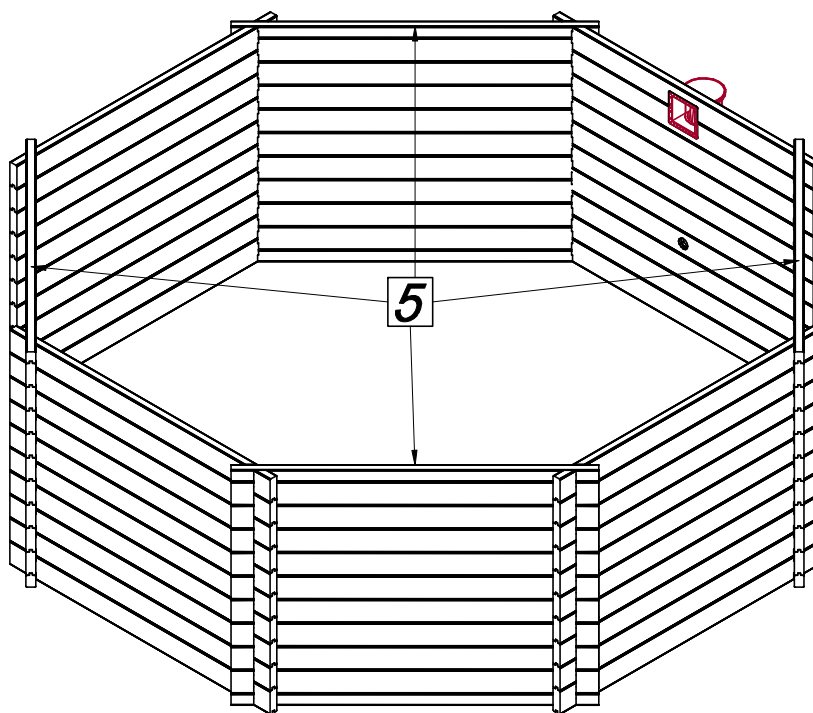
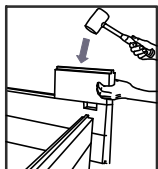

27

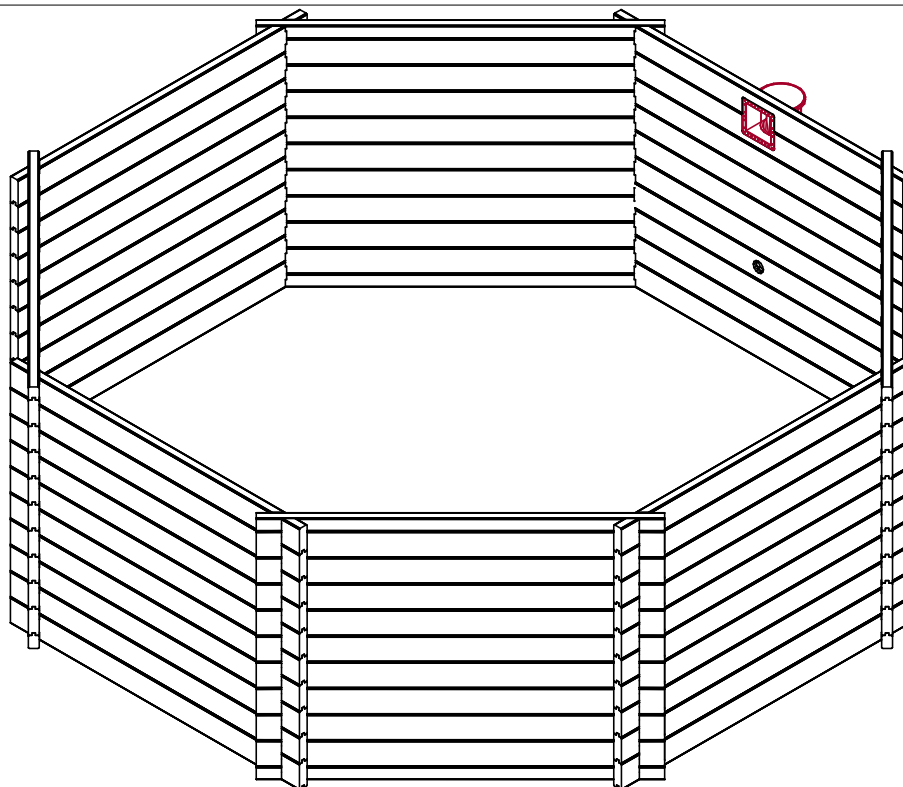

28

**PL** Struktura drewniana

**GB** Wooden structure

**D** Holzstruktur

**FR** La structure bois

**IT** Struttura in legno

**NL** Houten structuur



**PL** Montaż wspornika schodów (13).

**FR** Le montage du renfort d'escalier (13).

**GB** Installation of stairs support (13).

**IT** Montaggio delle scale a sbalzo (13).

**D** Montage von Treppenstützen(13).

**NL** Installatie van de steun voor de trap (13).

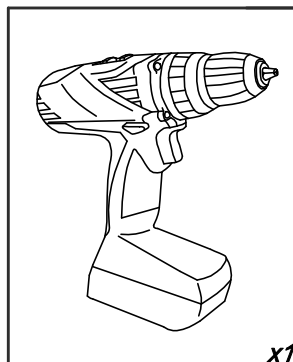

x1

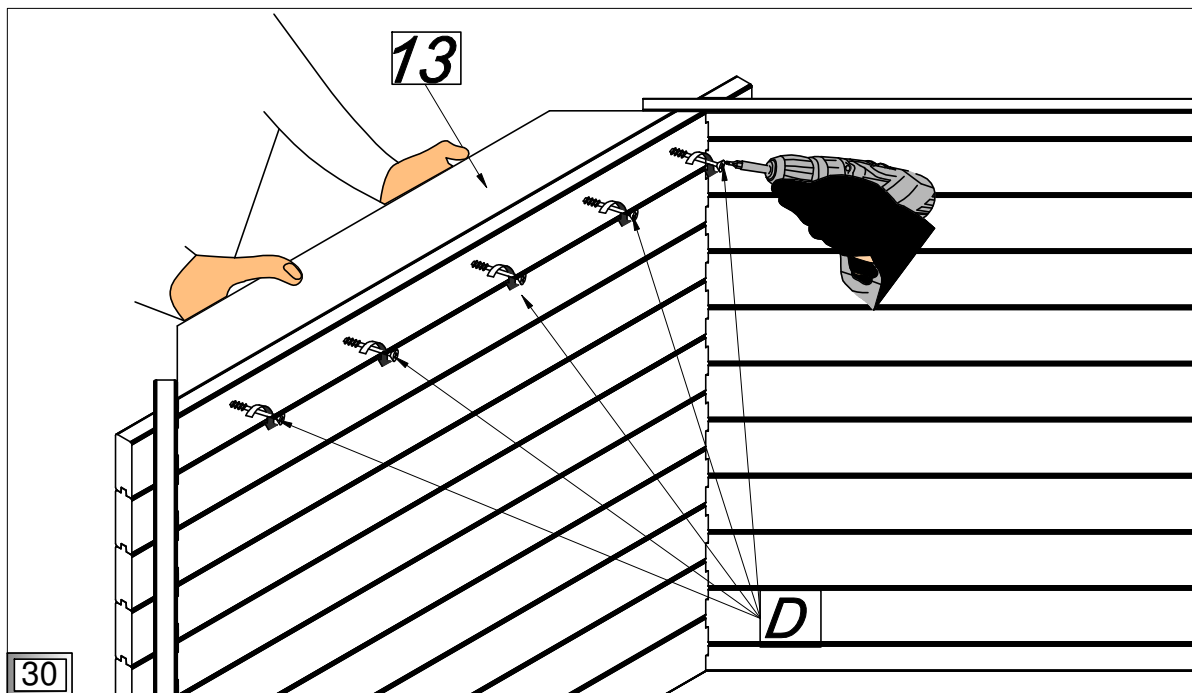
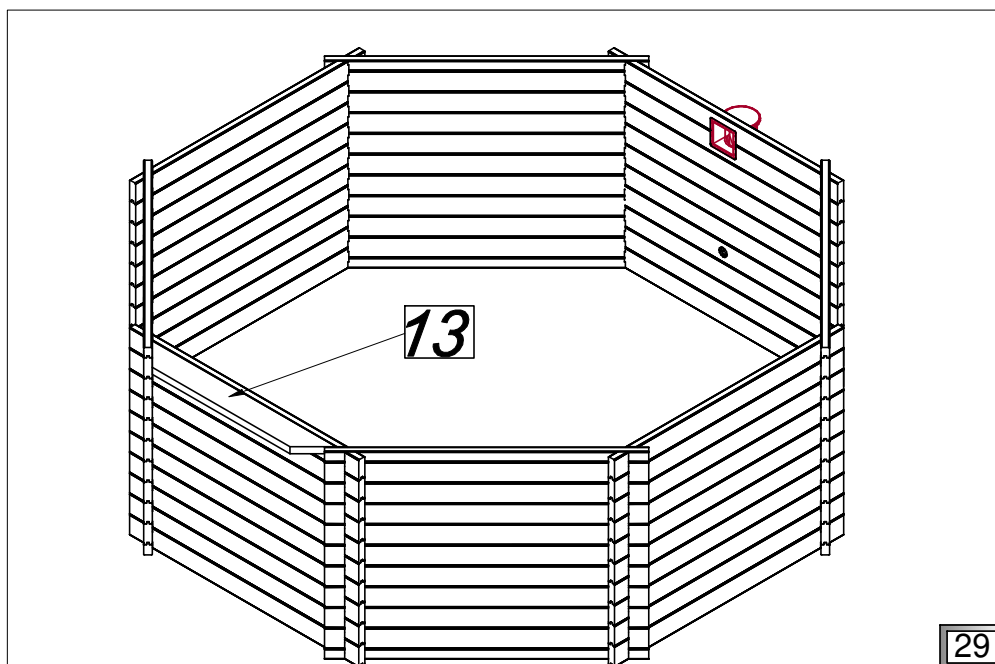
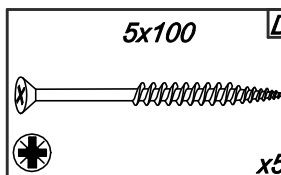
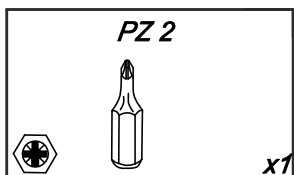
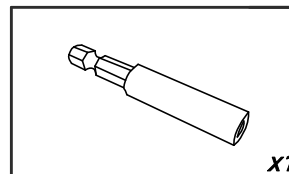
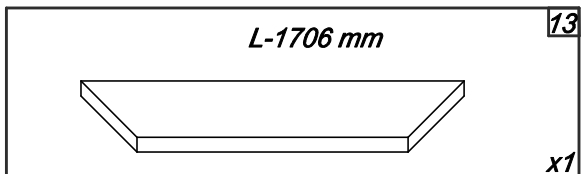

**(PL)** Struktura drewniana

**(GB)** Wooden structure

**(D)** Holzstruktur

**(FR)** La structure bois

**(IT)** Struttura in legno

**(NL)** Houten structuur



**(PL)** Rozłożenie wsporników pionowych (14,15) oraz konsol (20) według schematu.

**(FR)** La disposition des renforts verticaux (14,15) et des supports des margelles (20) d'après le schéma.

**(GB)** Arrangement of vertical supports (14,15) and consoles (20) according to the drawing.

**(IT)** La distribuzione degli sbalzi verticali (14,15) e delle console (20), secondo lo schema.

**(D)** Verteilung der vertikalen Stützen (14,15) und Konsolen (20) nach Schema.

**(NL)** Montage van de vertical steunen (14,15) en de consoles (20) volgens tekening.

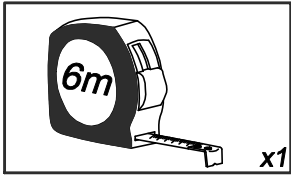

x1 [mm]

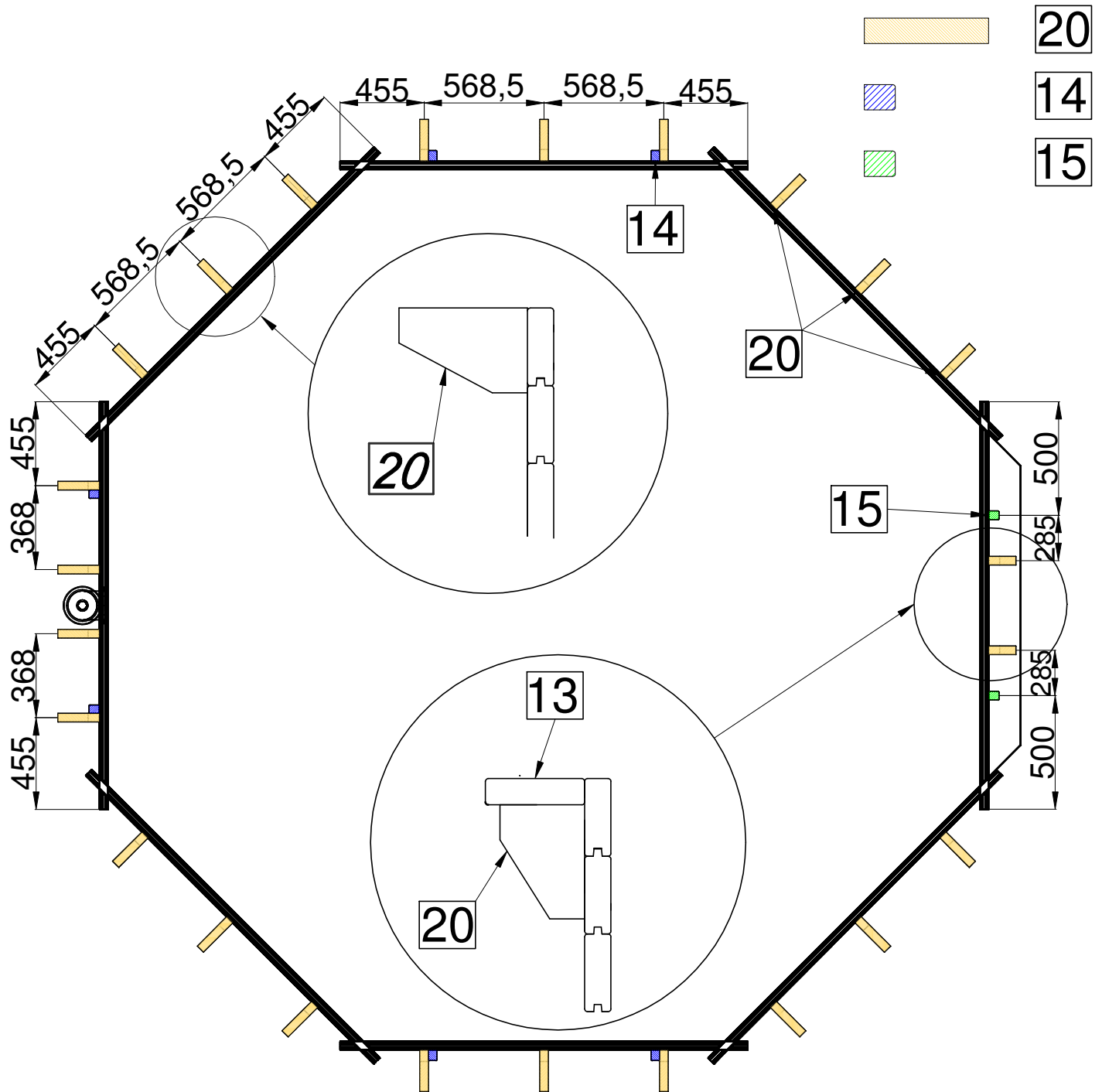

**PL** Struktura drewniana

**GB** Wooden structure

**D** Holzstruktur

**FR** La structure bois

**IT** Struttura in legno

**NL** Houten structuur



**PL** Montaż konsol (20). Konsole montowane pod wspomnikiem schodów (13) według rysunku 35.

**FR** Le montage des supports des margelles (20). Montez les supports des margelles sous un renfort d'escalier (13) d'après le dessin 35.

**GB** Installation of consoles (20). Consoles under ladder support (13) installed according to the drawing 35.

**IT** Il montaggio di consolle (20). Consolle sono montate sotto lo sbalzo della scala (13), come mostrato sul disegno 35.

**D** Konsolenmontage (20). Die Konsolen werden unter den Treppenstützen (13) nach Abb 35 montiert.

**NL** Installatie van de consoles (20). Consoles onder de ladder steun (13) volgens tekening 35.

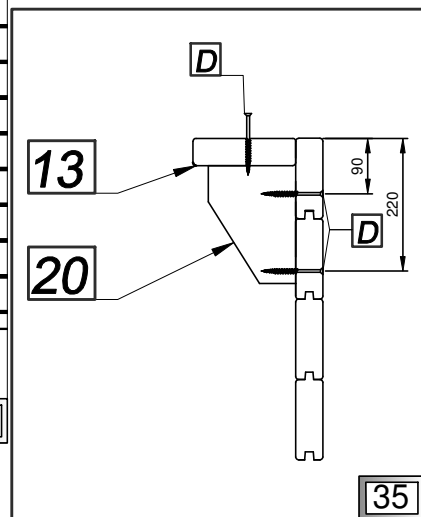
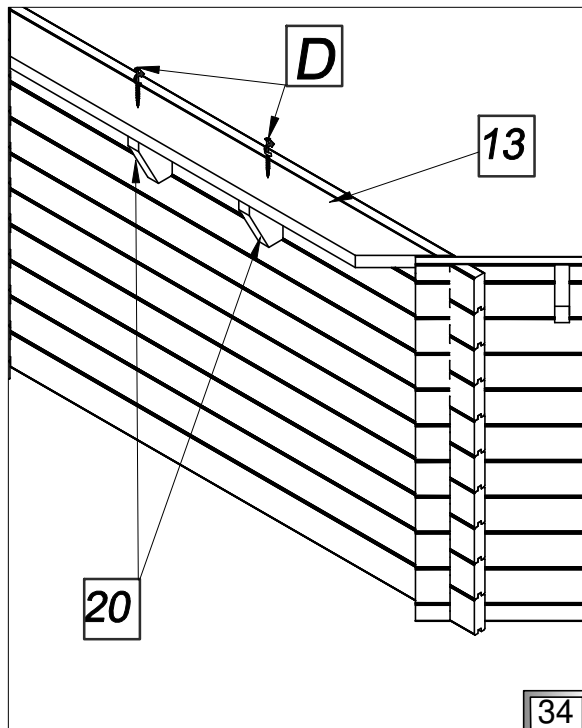
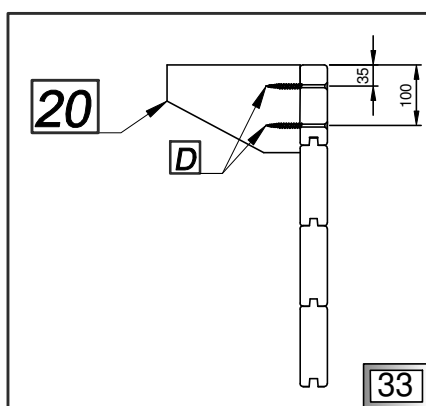
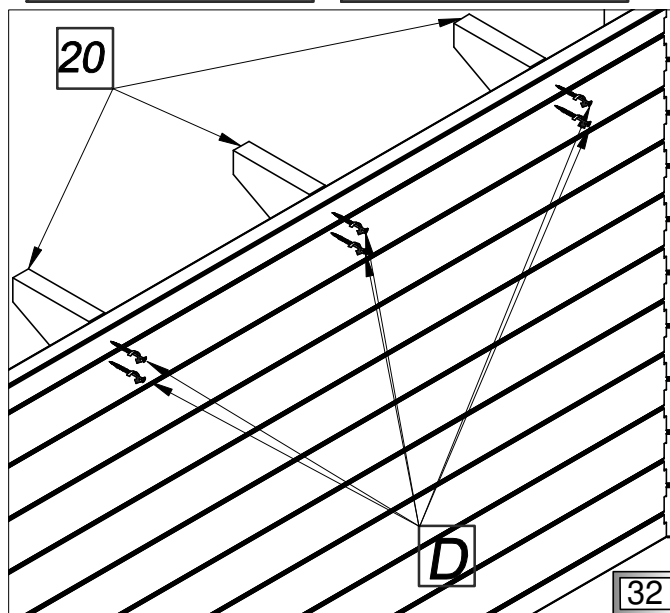
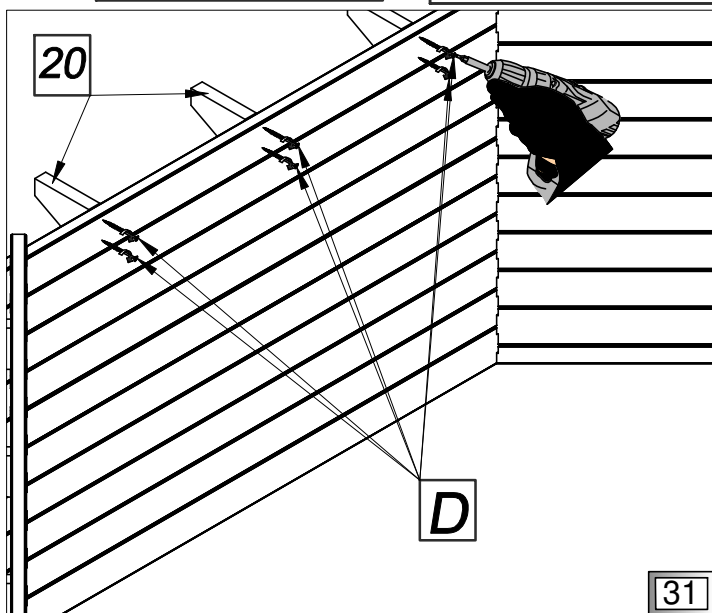
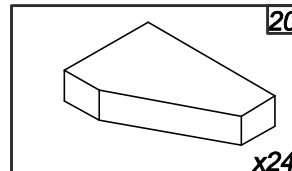
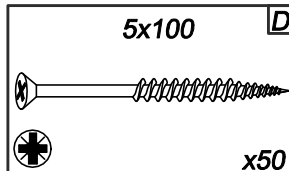
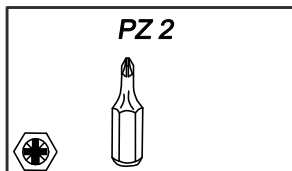
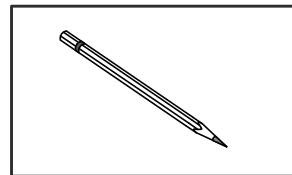
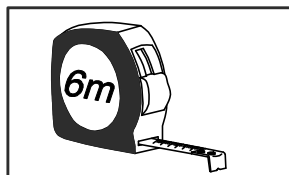
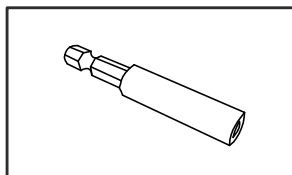
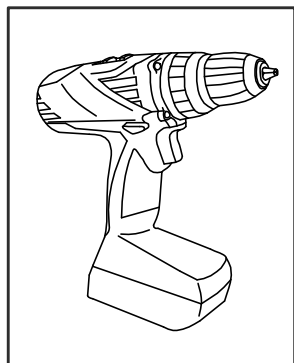



**(PL)** Struktura drewniana

**(GB)** Wooden structure

**(D)** Holzstruktur

**(FR)** La structure bois

**(IT)** Struttura in legno

**(NL)** Houten structuur



**(PL)** Montaż wsporników pionowych (14). Wkręty rozmieszczaj według rysunku 37.

**(FR)** Le montage des renforts verticaux (14). La disposition des vis d'après le dessin 37.

**(GB)** Installation of vertical supports (14). Arrange screws according to the drawing 37.

**(IT)** Montaggio degli sbalzi verticali (14). Mettere viti secondo il disegno 37.

**(D)** Montage von vertikalen Stützen (14). Schrauben sind nach Abb 37 angebracht.

**(NL)** Installatie van de verticale steunen (14), bepaal de schroeven volgens tekening 37.

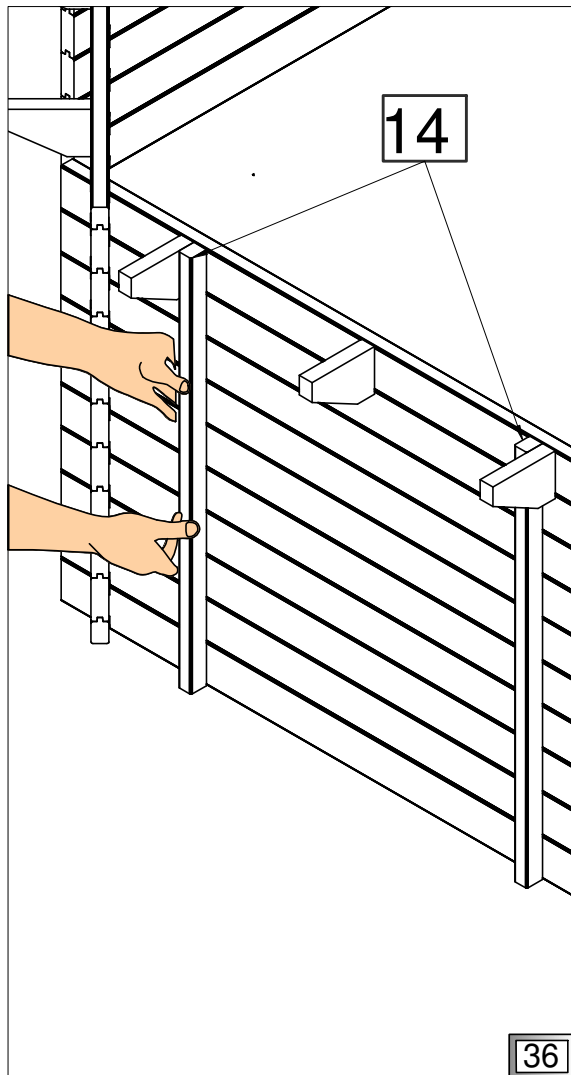
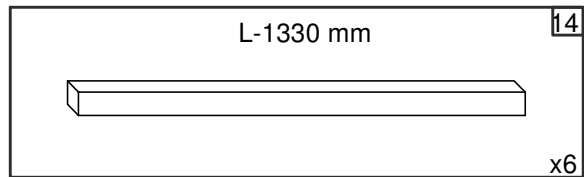
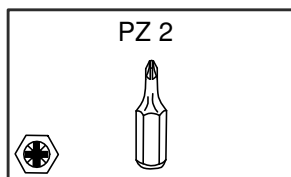
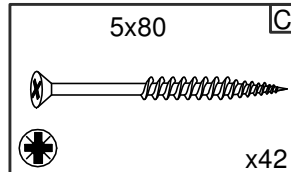
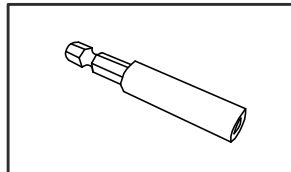
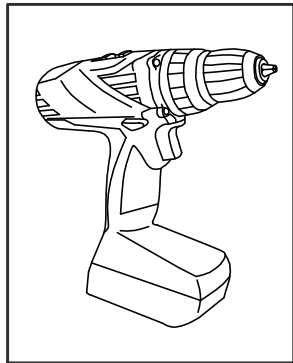

36

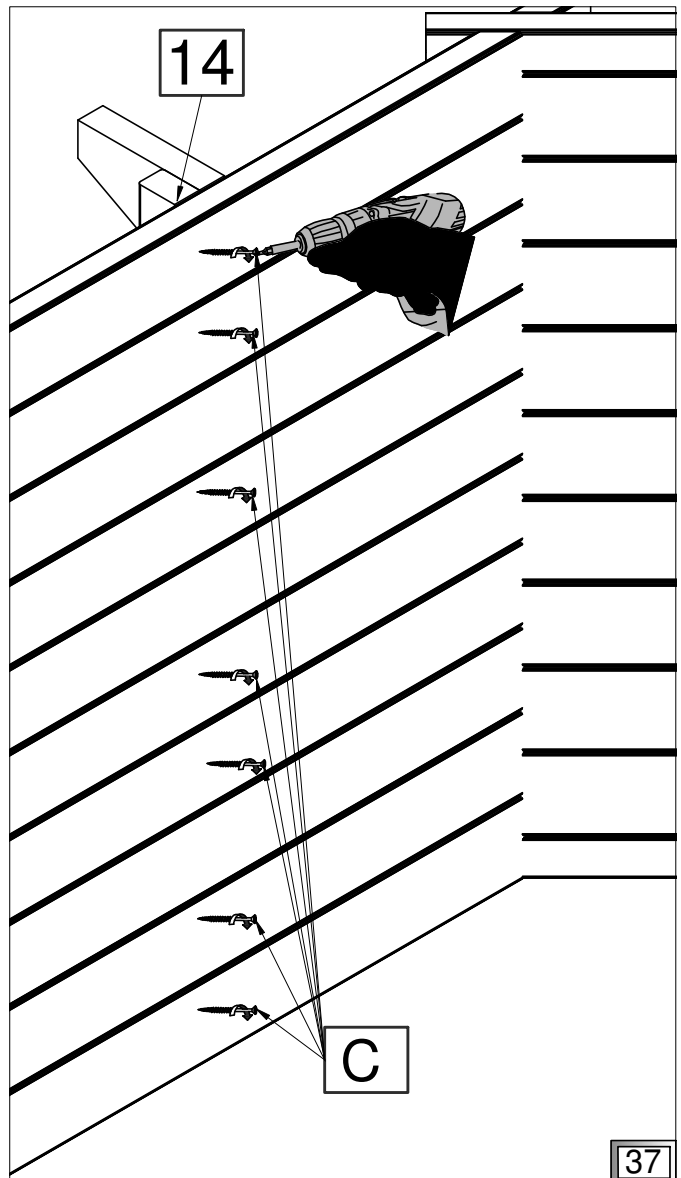

37

**(PL)** Struktura drewniana

**(GB)** Wooden structure

**(D)** Holzstruktur

**(FR)** La structure bois

**(IT)** Struttura in legno

**(NL)** Houten structuur



- (PL)** Montaż wsporników pionowych (15) pod wspornikiem schodów (13).
- (FR)** Le montage des renforts verticaux (15) sous un renfort d'escalier (13).
- (GB)** Installation of vertical supports (15) under the ladder support (13).
- (IT)** Installazione degli sbalzi verticali (15) sotto lo sbalzo delle scale (13).
- (D)** Montage von vertikalen Stützen (15) unter den Treppenstützen (13).
- (NL)** Installatie van de vertical steunen (15) onder de ladder steun (13).

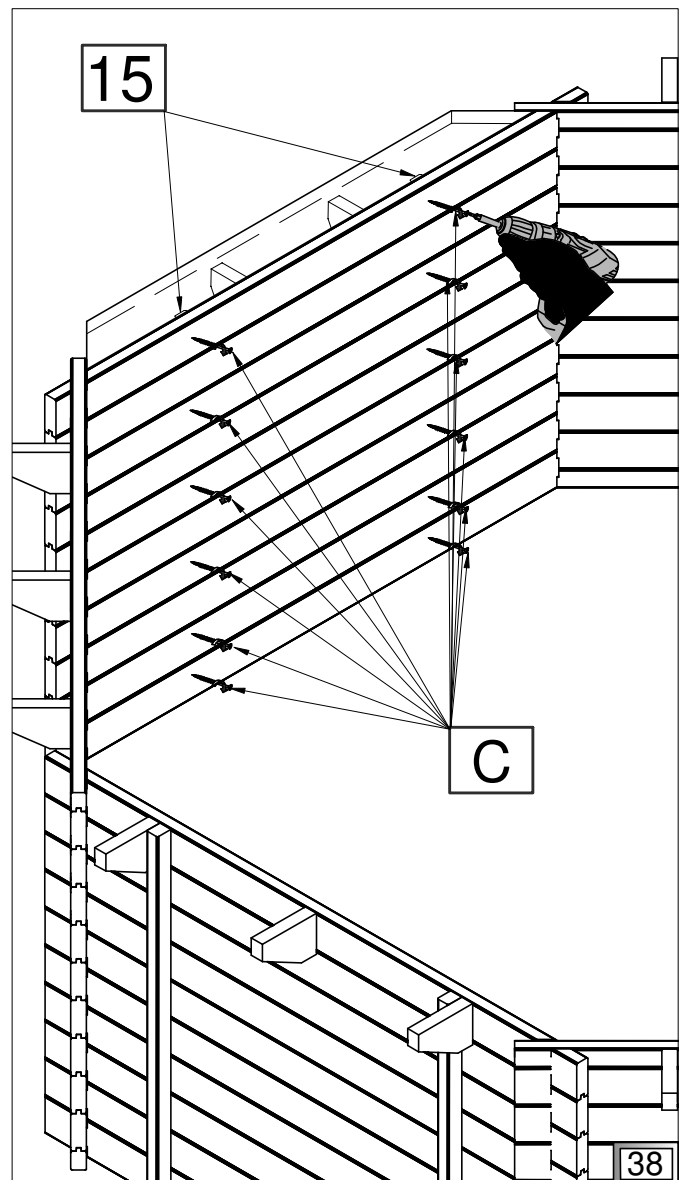
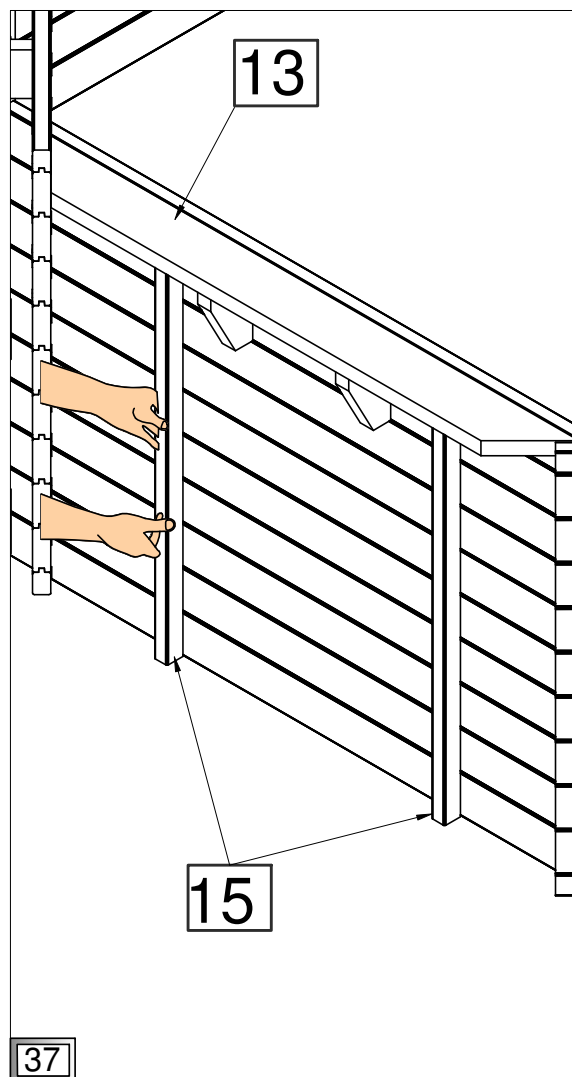
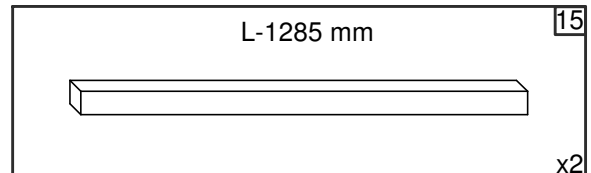
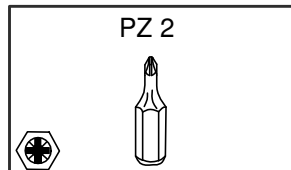
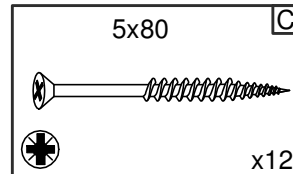
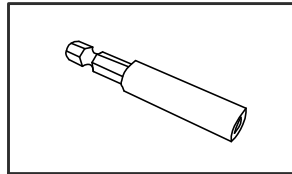
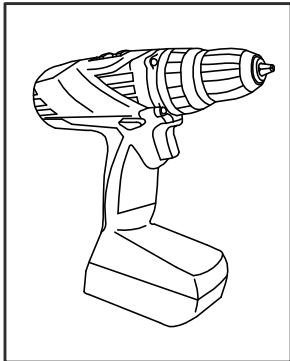

**(PL)** Struktura drewniana

**(GB)** Wooden structure

**(D)** Holzstruktur

**(FR)** La structure bois

**(IT)** Struttura in legno

**(NL)** Houten structuur



**(PL)** Montaż maskownicy 57 mm (19).

**(FR)** Le montage des caches 57 mm (19).

**(GB)** Installation of the masking element 57 mm (19).

**(IT)** Montaggio del mascherino 57 mm (19).

**(D)** Montage der Abdeckung 57 mm (19).

**(NL)** Installatie van de afwerklad 57mm (19) voor de kopse kanten van de wanddelen.

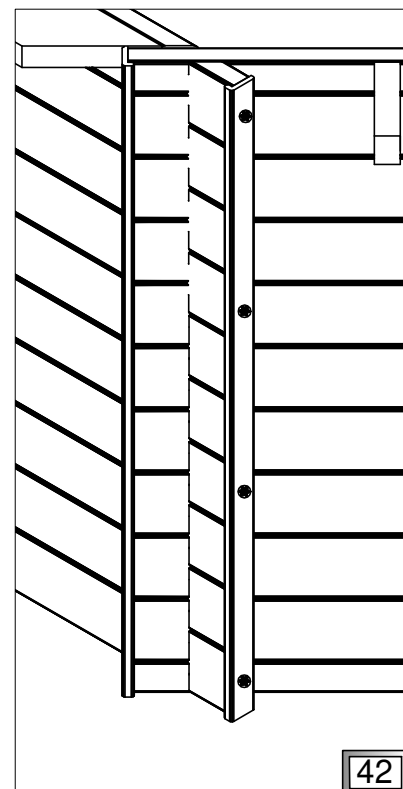
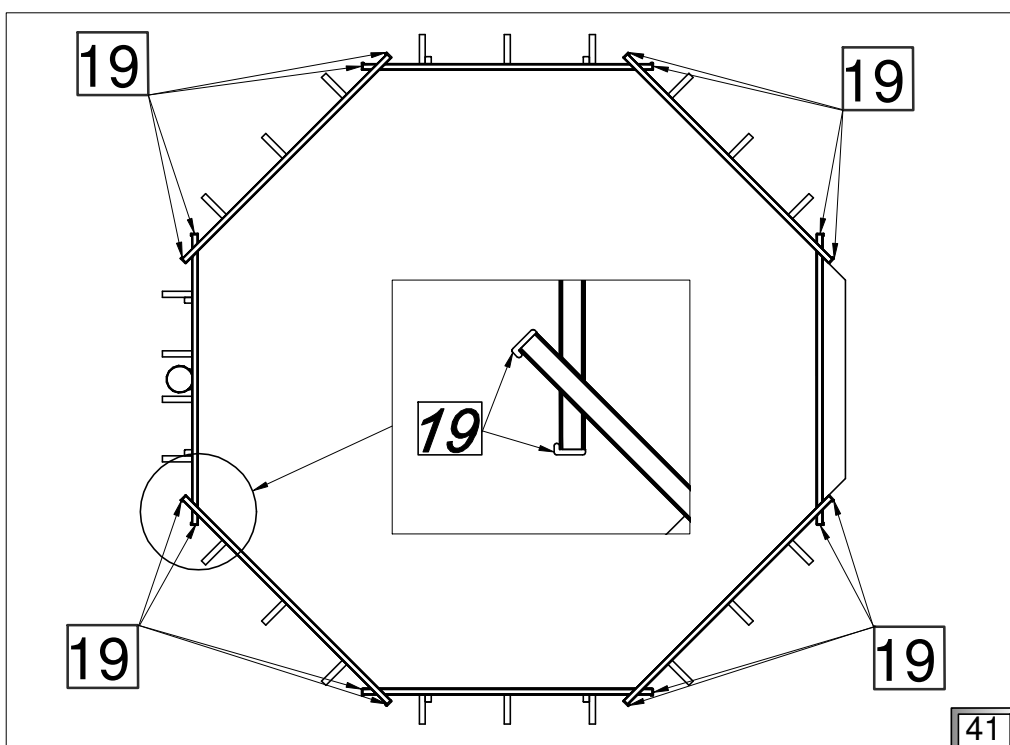
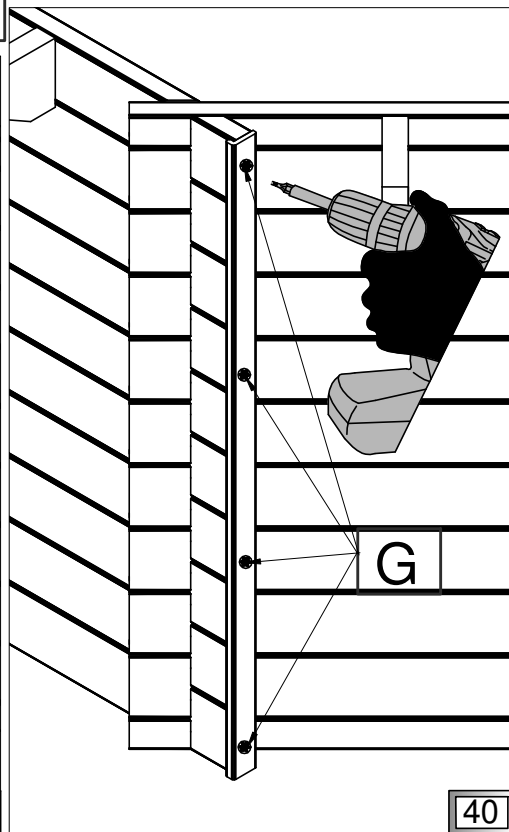
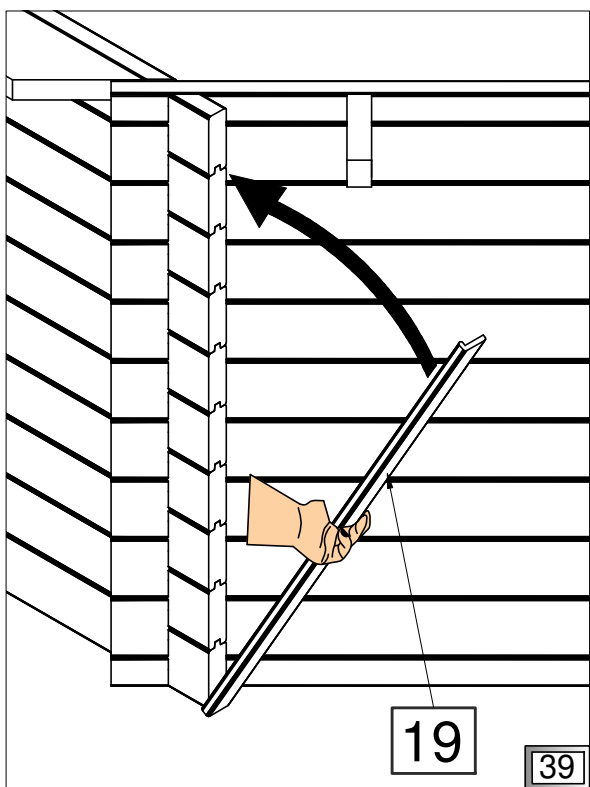
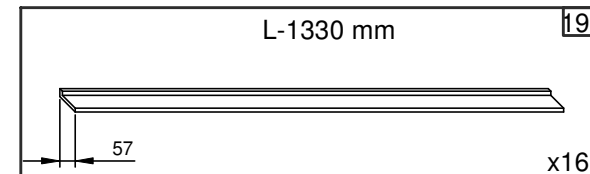
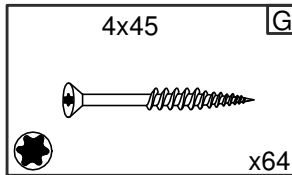
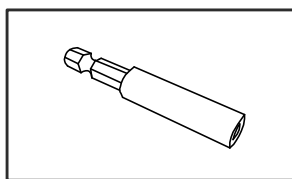
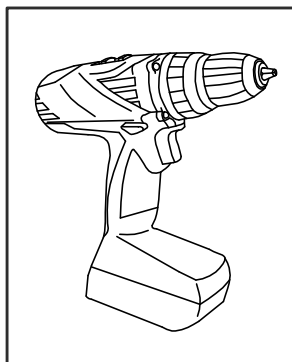

**(PL) Geowłóknina**

**(GB) Geotextile**

**(D) Geotextilien**

**(FR) Le géotextile**

**(IT) Geotessile**

**(NL) Geotextiel**



**(PL)** Rozłożenie geowłókniny (S). Nakleić włókninę na wewnętrzną stronę basenu za pomocą taśmy 2-stronnej bądź kleju.

**(FR)** La pose du feutre (S). Collez le feutre a l'interieur de la structure a l'aide de la colle ou du ruban adhésif double face.

**(GB)** The distribution of geotextile (S). Glue the geotextile to the inner side of pool wall. Use double-side tape or glue.

**(IT)** La distribuzione di geotessile (S). Incollì il geotessile al lato interno di muro di piscina. Usa nastro a due facce o colla.

**(D)** Die Verteilung von geotextile (S). Kleben Sie den geotextile an die innere Seite der Wand. Brauchen Sie zweiseitiges Band oder Leim.

**(NL)** De verdeling van de geotextiel (S). Lijm het vezelvlies op de binnenwand van het zwembad door middel van dubbelzijdig plakband of lijm.

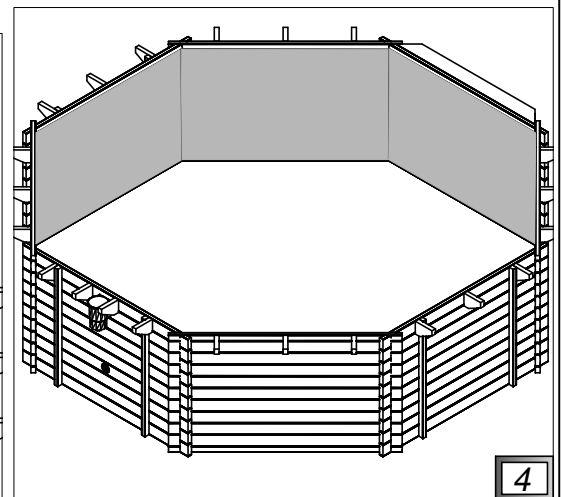
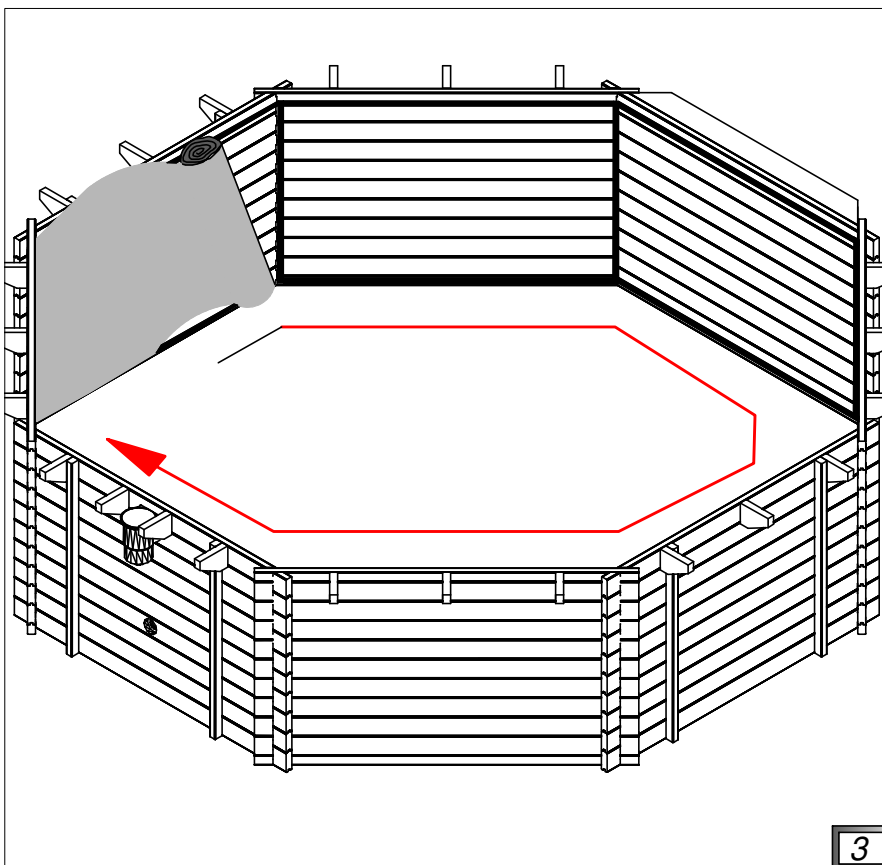
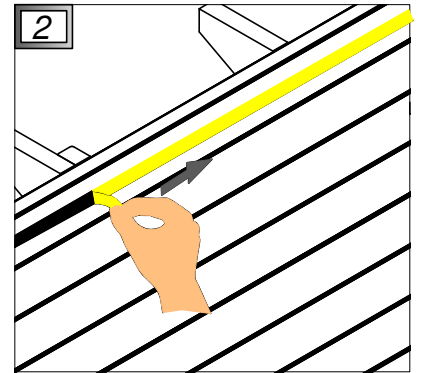
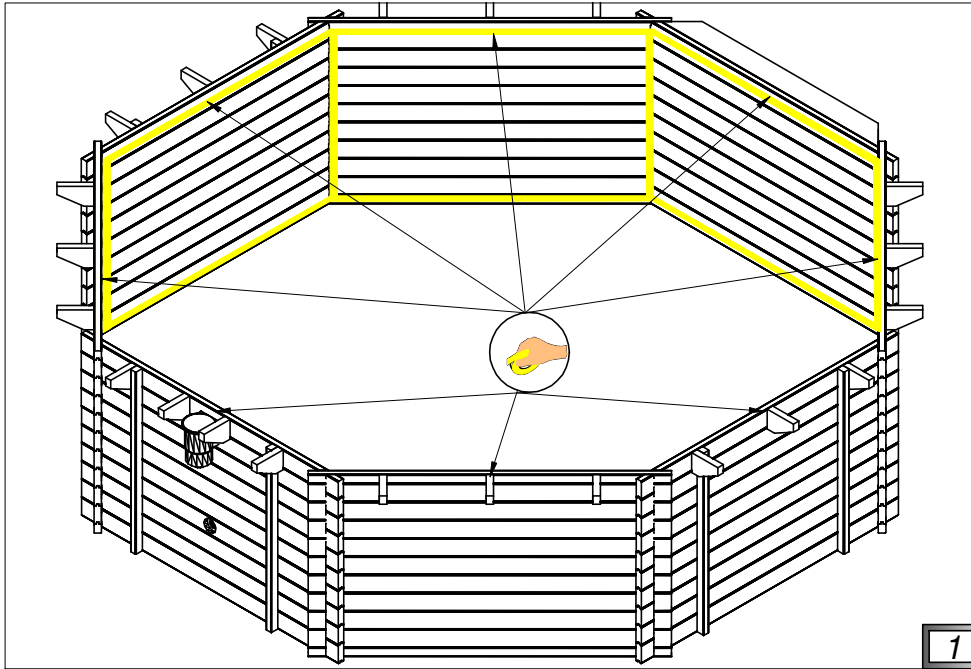
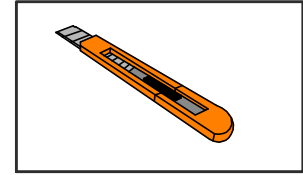
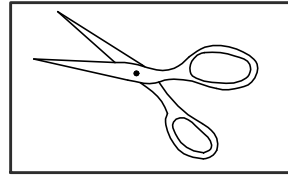
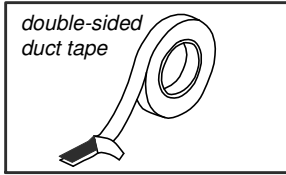
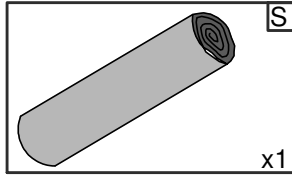

**(PL) Profile PVC**

**(GB) PVC profiles**

**(D) PVC-Profile**

**(FR) Les profils PVC**

**(IT) Profili in PVC**

**(NL) PVC profielen**



**(PL)** Profile PVC (J) przyciąć na wymiar. Wykonać otwory  $\varnothing 2$  mm wg schematu.

**(FR)** Coupez les profils (J) d'accrochage et faites les pré-perçements  $\varnothing 2$  mm d'après le schéma.

**(GB)** Cut PVC profiles (J) according to the drawing. Make holes  $\varnothing 2$  mm according to the scheme.

**(IT)** Profili in PVC (J) adottare alla dimensione. Eseguire due fori  $\varnothing 2$  mm secondo lo schema.

**(D)** Die PVC-Profile (J) auf Maß schneiden. Die  $\varnothing 2$  mm-Öffnungen nach Schema bohren.

**(NL)** Zaag de PVC profielen (J) volgens tekening. Maak gaten van 2 mm volgens schema.

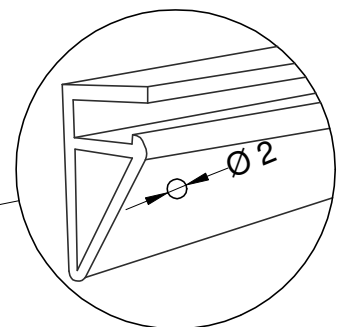
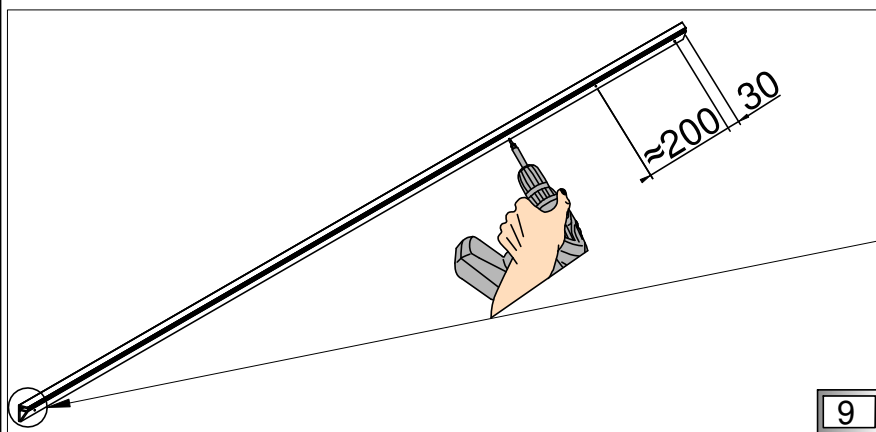
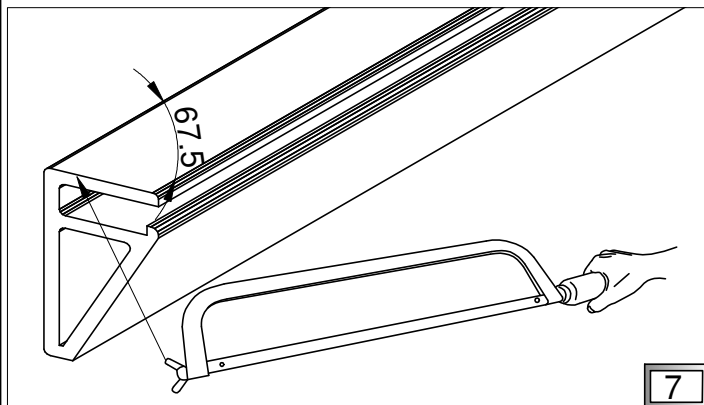
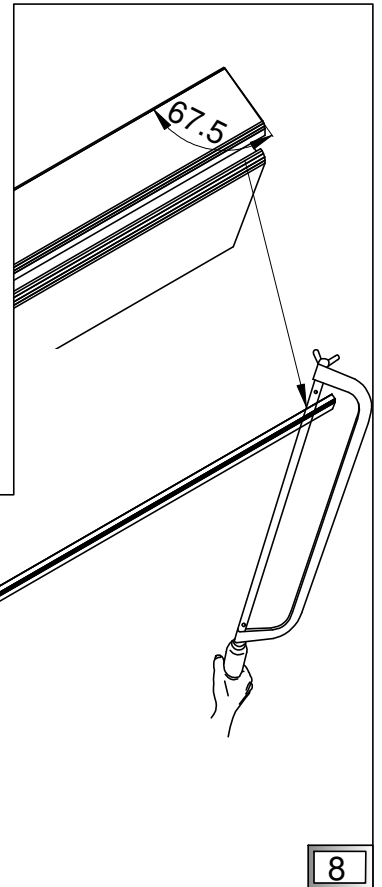
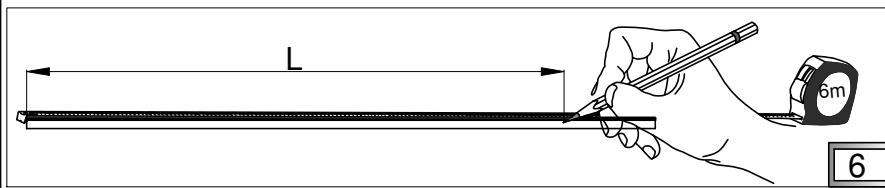
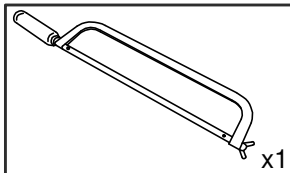
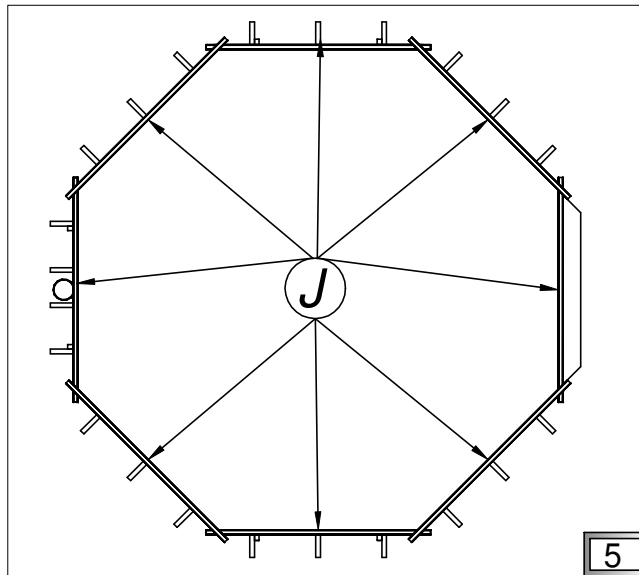
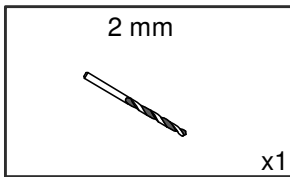
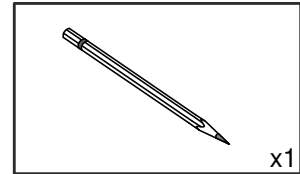
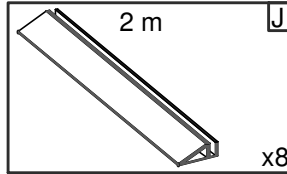
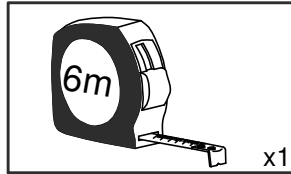
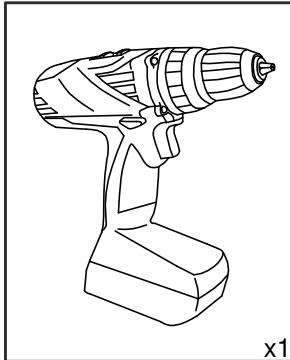

**(PL) Profile PVC**

**(GB) PVC profiles**

**(D) PVC-Profil**

**(FR) Les profils PVC**

**(IT) Profili in PVC**

**(NL) PVC profielen**



**(PL)** Montaż profili PVC (J) do struktury drewnianej. Profile (J) łączymy na żadaną długość.  
**(FR)** Le montage des profils d'accrochage PVC (J) à la structure. Unissez les profils (J) à la longueur.  
**(GB)** Mounting PVC profiles (J) to the wooden structure. Join profiles (J) to achieve desired length.  
**(IT)** Il montaggio di profili in PVC (J) per strutture in legno. Il profili (J) combinare per la lunghezza desiderata.  
**(D)** Montage von PVC-Profilen (J) an die Holzkonstruktion. Profile (J) sind nach der gewünschten Länge zu verbinden.  
**(NL)** Montage PVC profielen (J) aan het houten frame en zaag de PVC profielen (J) in verstek om de hoeken passend te maken.

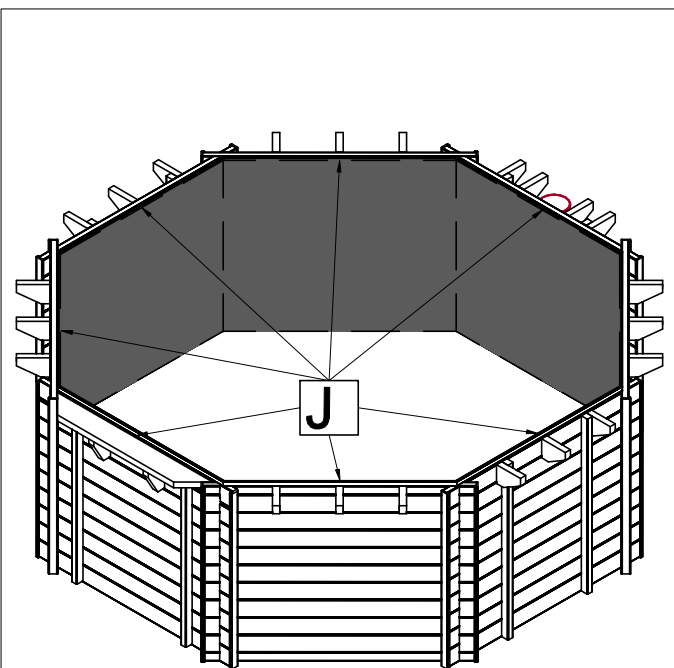
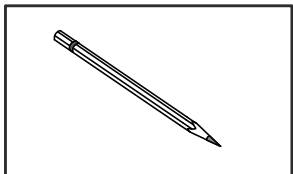
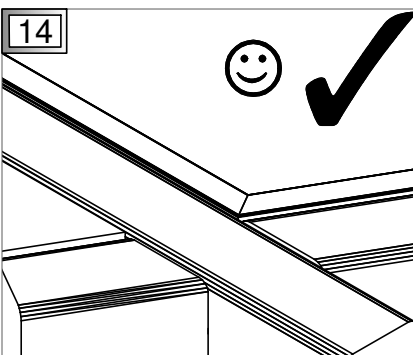
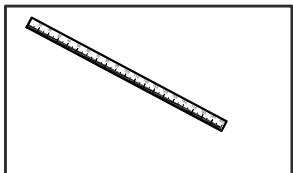
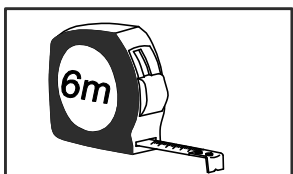
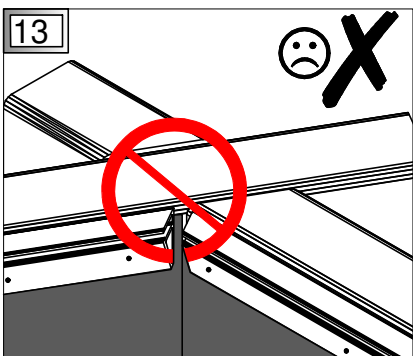
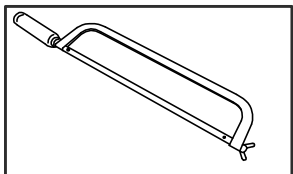
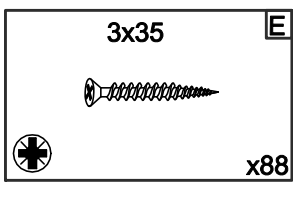
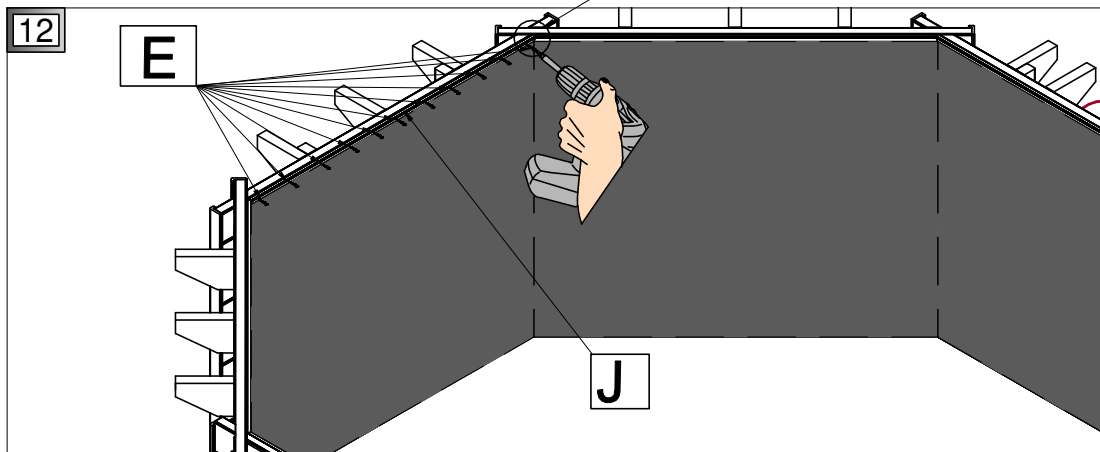
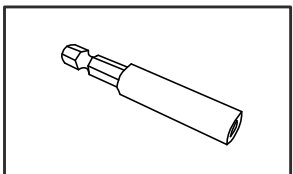
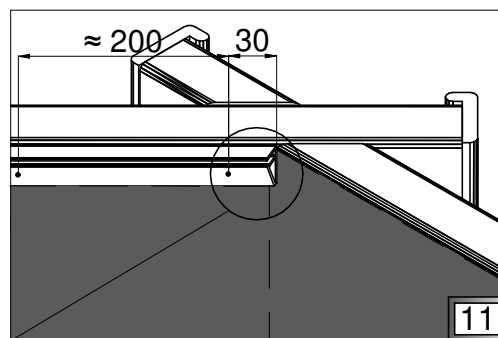
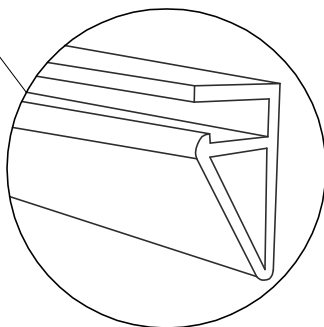
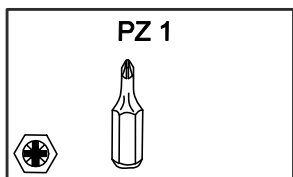
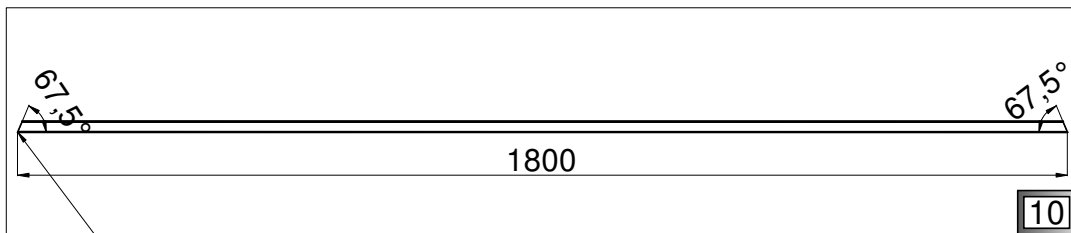
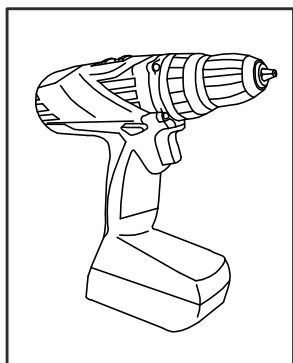

**(PL)** Geowlóknina i liner

**(GB)** Geotextile and liner

**(D)** Geotextilien und Liner

**(FR)** Le géotextile et la liner

**(IT)** Geotessile e liner

**(NL)** Geotextiel en liner



**(PL)** Rozłożenie geowlókniny (K) oraz liner (foli basenowej) (L).

**(FR)** La mise en place du feutre (K) et de la liner (L).

**(GB)** Installation of the geotextile (K) and liner (L).

**(IT)** Distribuzione di geotessile (K) e di liner (fogli per piscina) (L).

**(D)** Verteilung von Geotextilien (K) und von Liner (Einhängfolie) (L).

**(NL)** Installatie van het geotextiel (K) en liner (L).

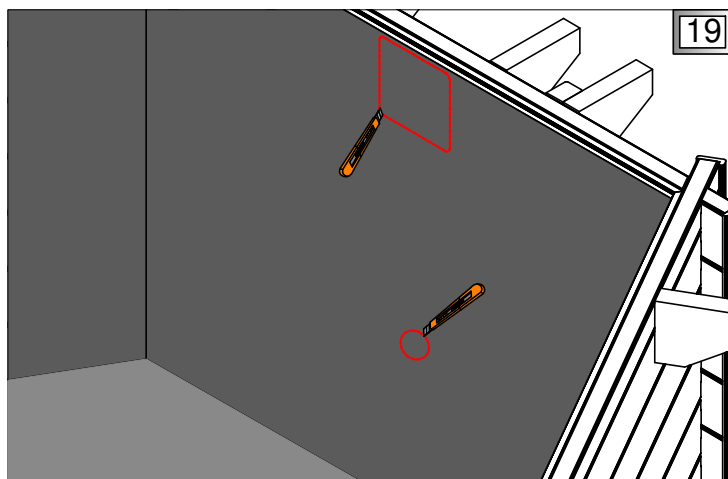
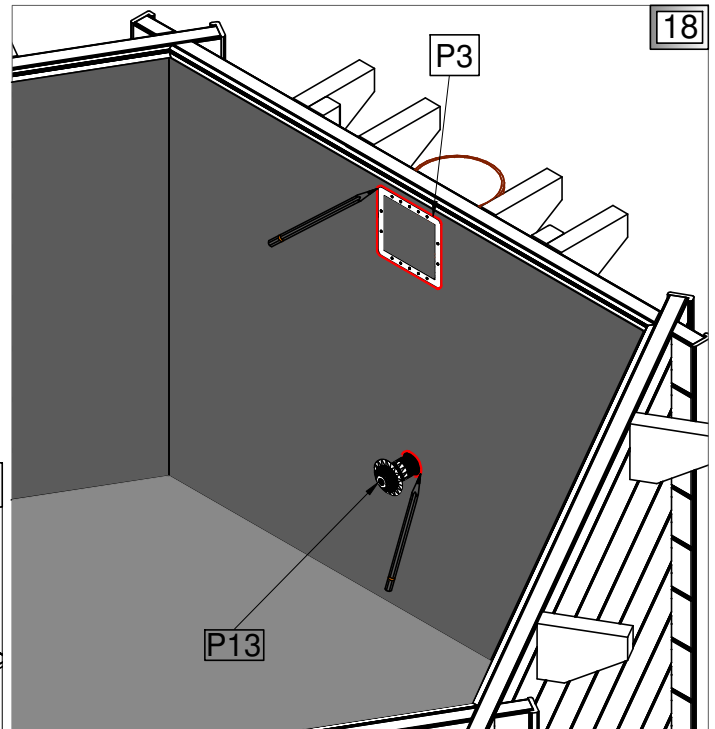
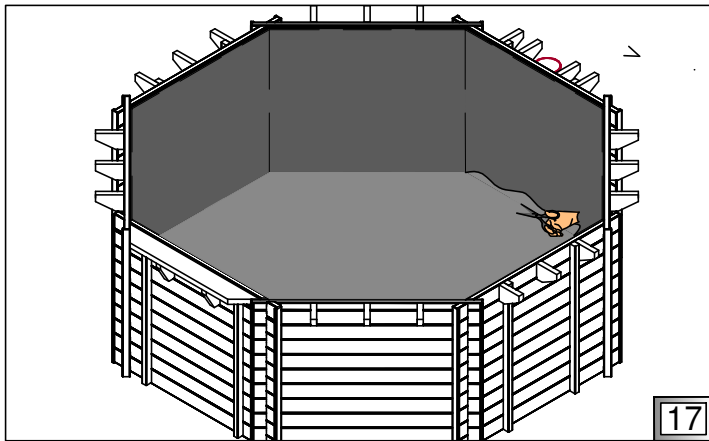
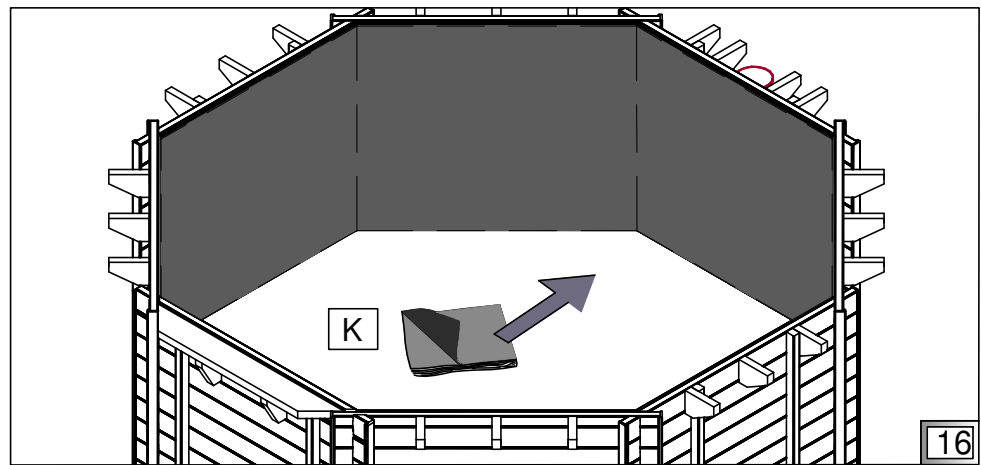
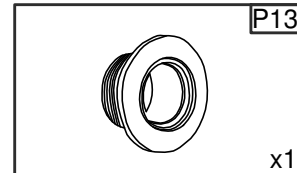
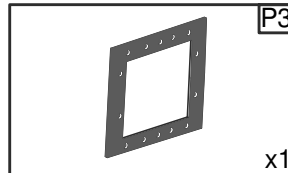
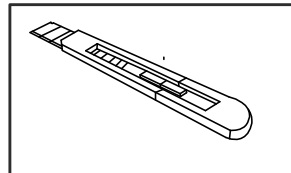
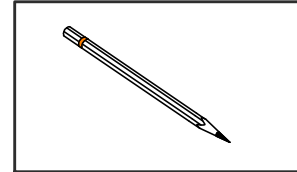
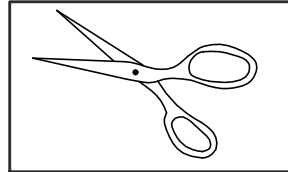
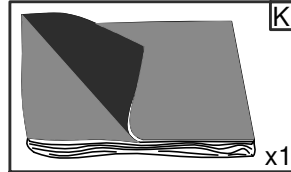
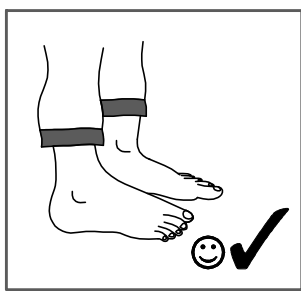

**(PL)** Geowlóknina i liner

**(GB)** Geotextile and liner

**(D)** Geotextilien und Liner

**(FR)** Le géotextile et la liner

**(IT)** Geotessile e liner

**(NL)** Geotextiel en liner



**(PL)** Rozłożenie liner (foli basenowej) (L).

**(FR)** La mise en place de la liner (L).

**(GB)** Installation of the liner (L).

**(IT)** Distribuzione di liner (foglia per piscina) (L).

**(D)** Verteilung von Liner (Einhängfolie) (L).

**(NL)** Installatie van liner (L).

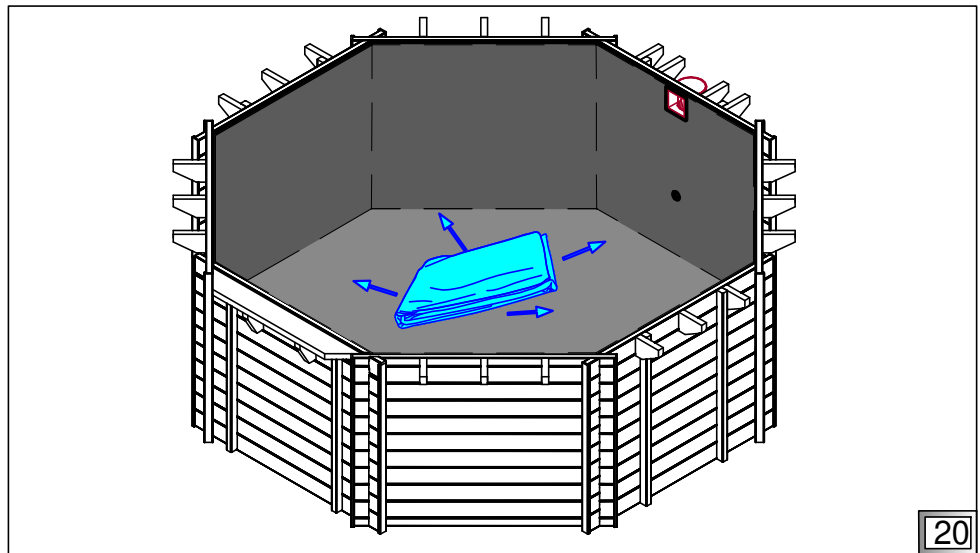
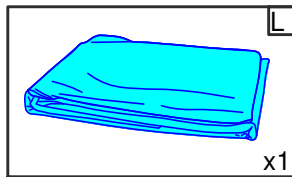
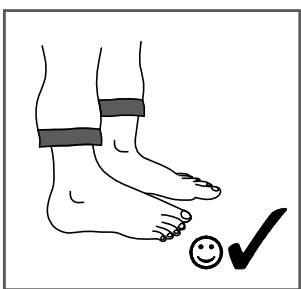

20

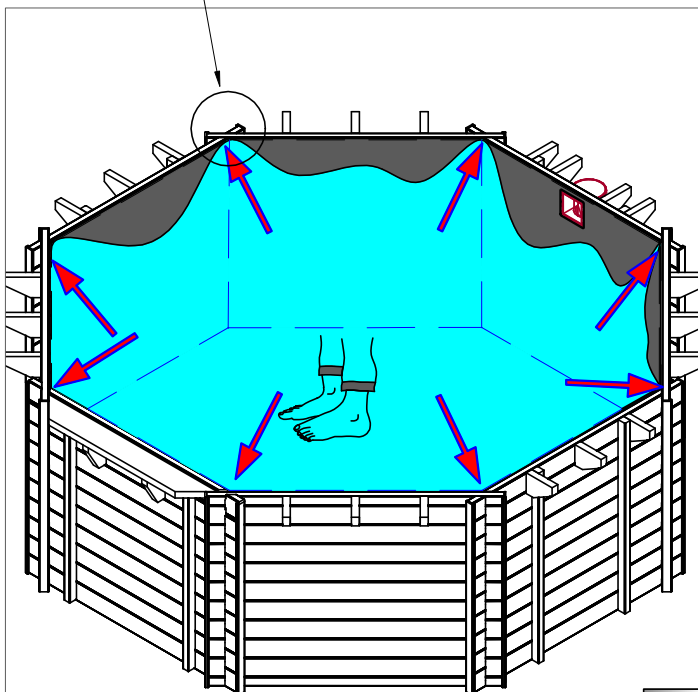
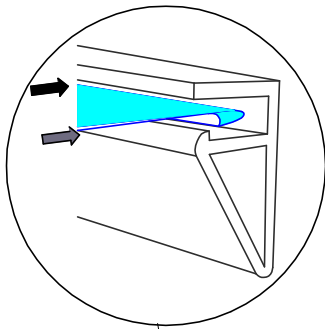

21

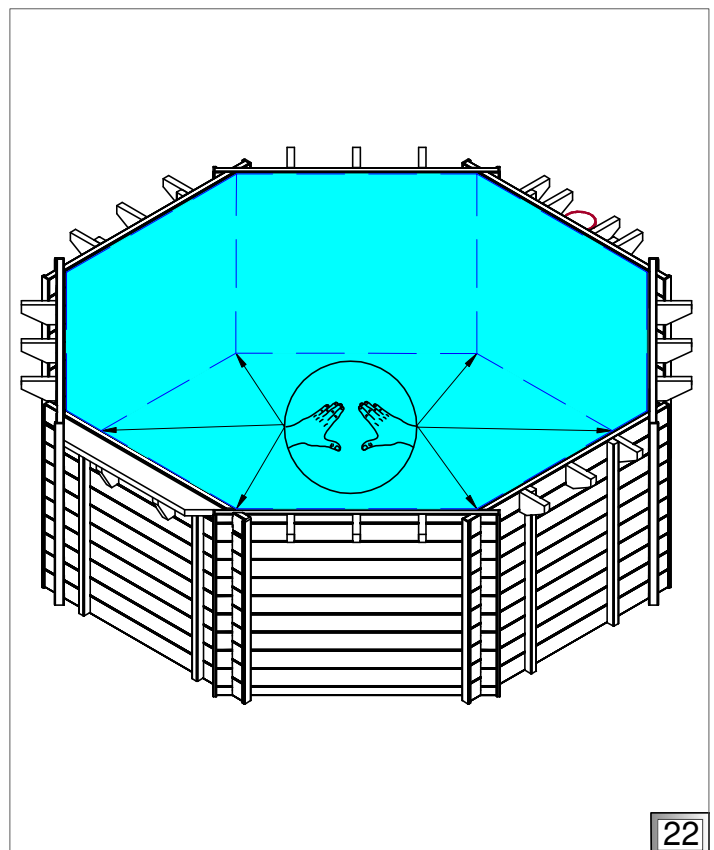

22



**(PL) Liner**

**(GB) Liner**

**(D) Liner**

**(FR) Liner**

**(IT) Liner**

**(NL) Binnen bekleding**



- (PL)** Montaż lineru oraz stopera (M) w profilach PVC (J).
- (FR)** Le montage de la liner et de la bandelette (M) pour les profils d'accrochage (J).
- (GB)** Mounting the liner and liner lock (M) in PVC profiles (J).
- (IT)** Il montaggio di liner e tappo (M) in profili in PVC (J).
- (D)** Montage von Liner und von Stopper (M) in den PVC-Profilen (J).
- (NL)** Montage van de binnen bekleding (M) in de PVC profielen (J).

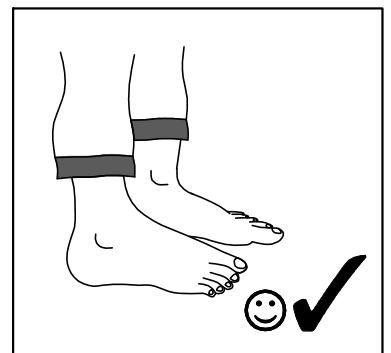
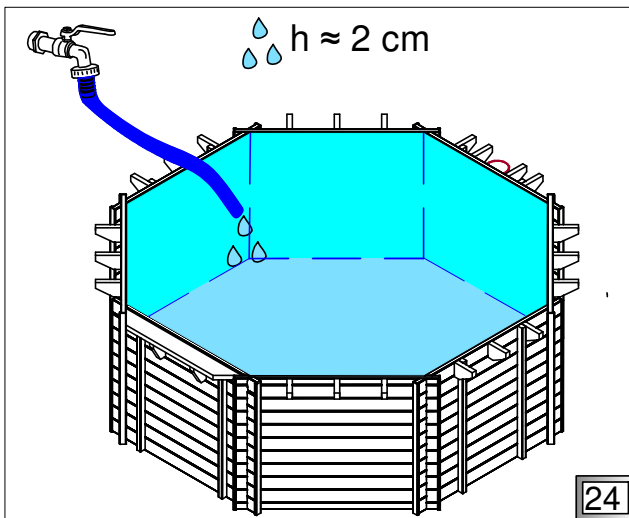
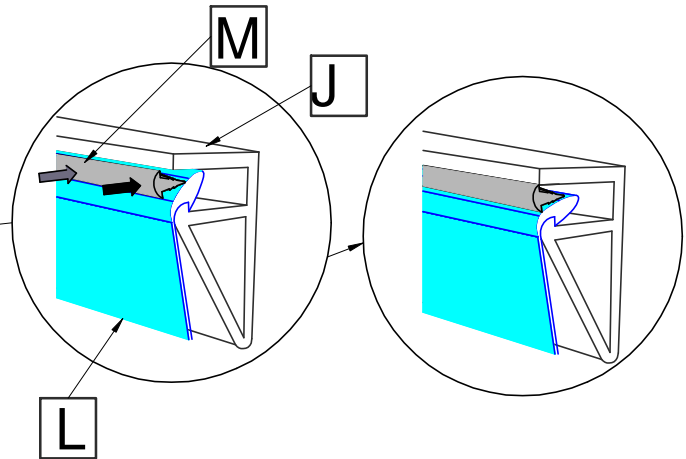
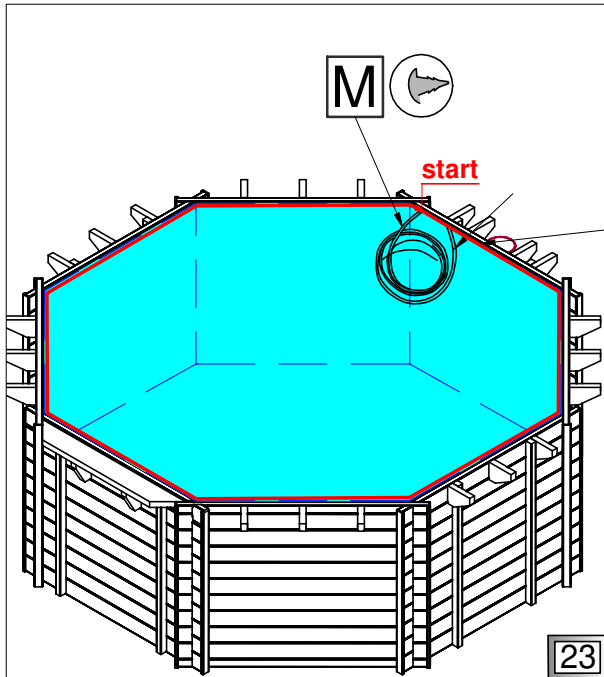
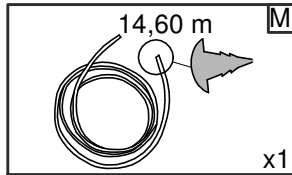
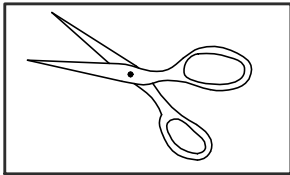

- (PL)** Wyrównaj sfaldowania po nalaniu wody.
- (FR)** Etalez les plis après avoir mis de l'eau.
- (GB)** Smooth all folds after pouring water.
- (IT)** Allineare le piegature dopo il versamento di acqua.
- (D)** Gleichen Sie Faltungen aus wenn das Wasser aufgegossen wurde.
- (NL)** Strijk alle plooiën glad na het vullen van water.

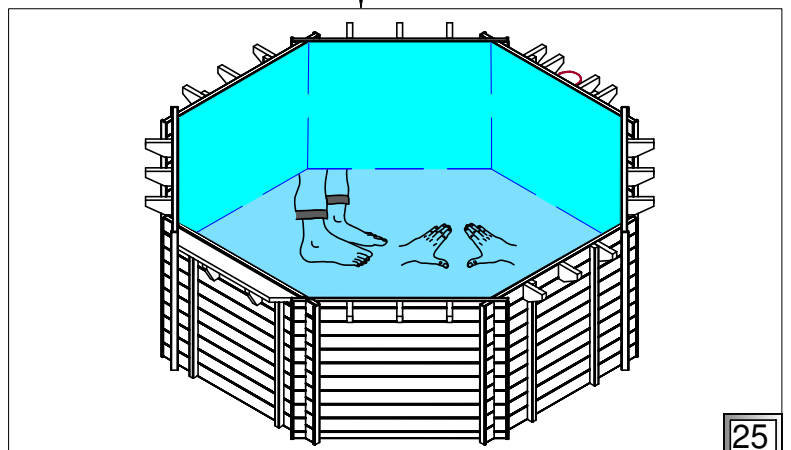
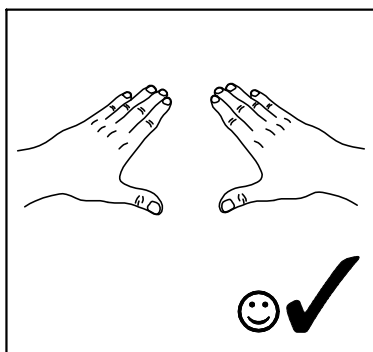

**(PL) Dysze**

**(GB) Nozzles**

**(D) Düsen**

**(FR) Les buses de refoulement**

**(IT) Ugelli**

**(NL) Inlaat**



**(PL)** Po kolejnym nalaniu wody wyrównać sfałdowania. Wytnij otwór pod dyszę.

**(FR)** Après le versement de l'eau éliminez les plis. Faites les trous à la buse de refoulement.

**(GB)** After pouring the water smooth all folds. Cut the hole for the nozzle.

**(IT)** Dopo un altro riempimento di acqua livellare le pieghe. Ritagliare i fori fino all'ugello.

**(D)** Nachdem Wasser wieder eingegossen wird, sind Faltungen zu ebnen. Öffnungen für die Düsen sind zu schneiden.

**(NL)** Na het gladstrijken van de plooiën snij een gat voor de inlaat.

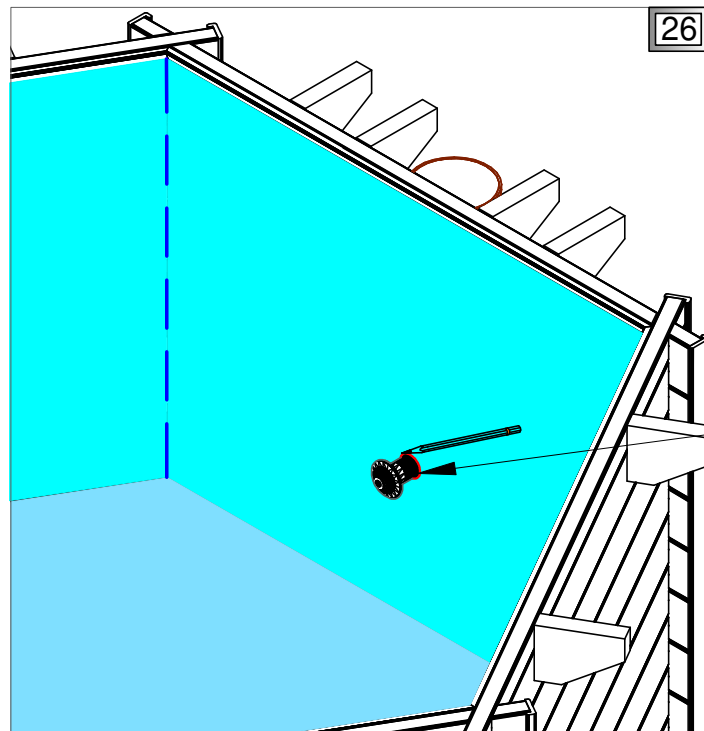
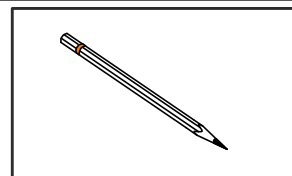
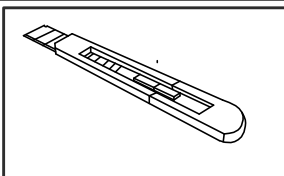
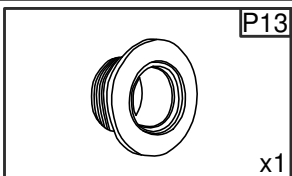
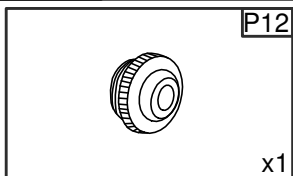

26

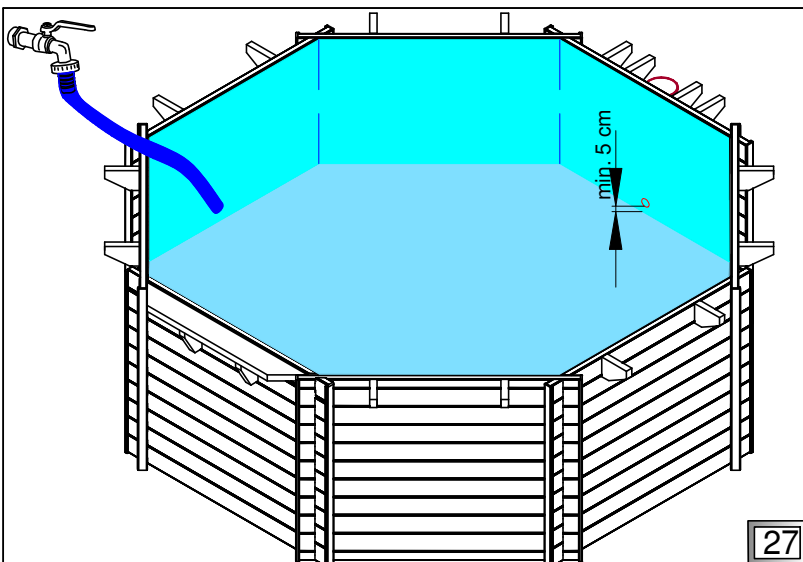
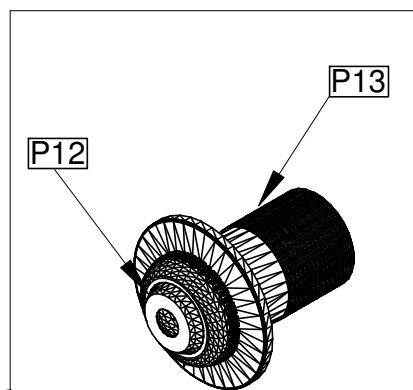

27

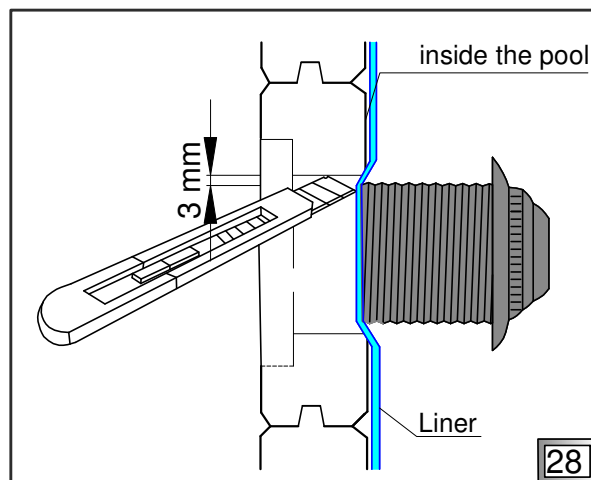

28

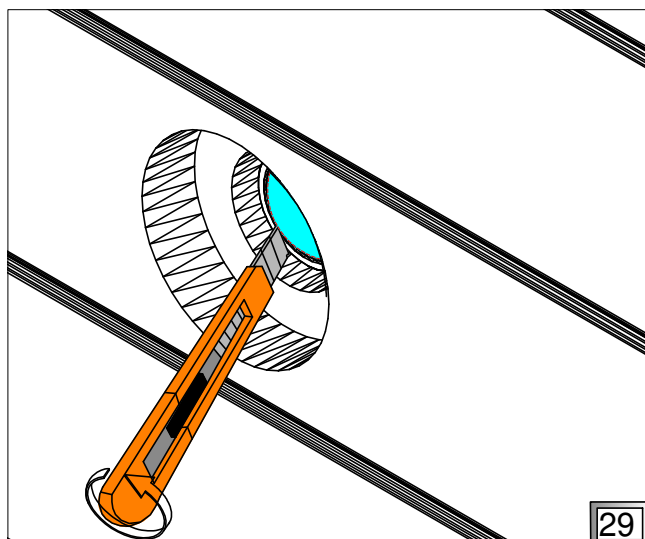

29

**(PL) Dysze**

**(GB) Nozzles**

**(D) Düsen**

**(FR) Les buses de refoulement**

**(IT) Ugelli**

**(NL) Inlaat**



**(PL)** Uszczelki (P11) posmarować wazeliną od strony linera. Mocowanie dysz.

**(FR)** Etalez de la vaseline sur les joints (P11) du côté de la liner. Le montage de la buse de refoulement.

**(GB)** Smear liner facing side of the gasket (P11) with vaseline. Installation of nozzles.

**(IT)** Sui sigilli (P11) da parte di liner mettere la vaselina. Fissaggio dei ugelli.

**(D)** Die Dichtungen (P11) sind von der Seite der Liner mit der Vaseline zu schmieren. Befestigung von Düsen.

**(NL)** Smeer de pakking (P11) in met vaseline. Installatie van de inlaat.

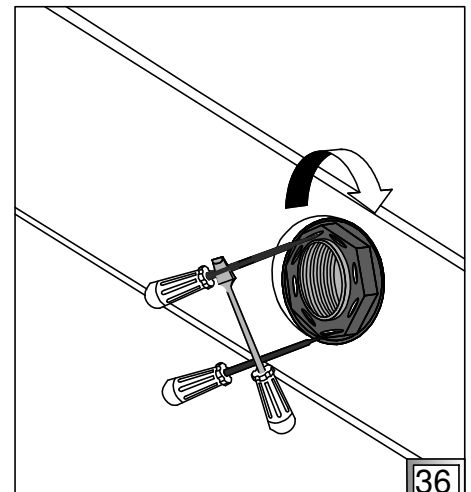
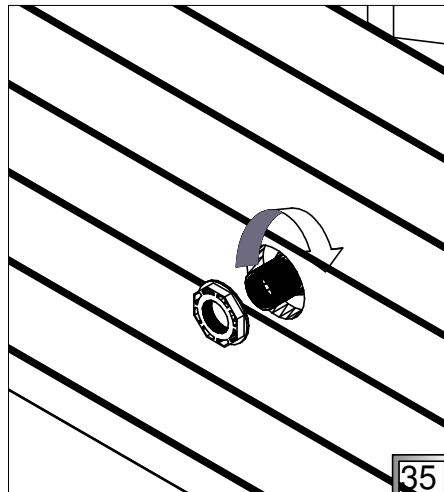
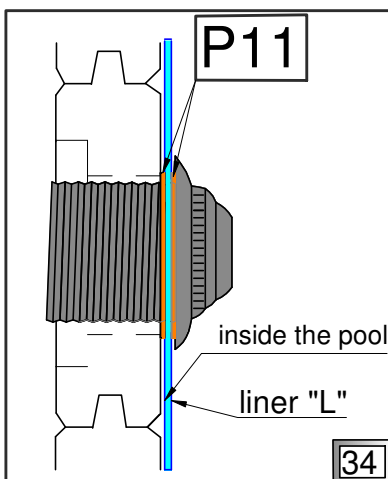
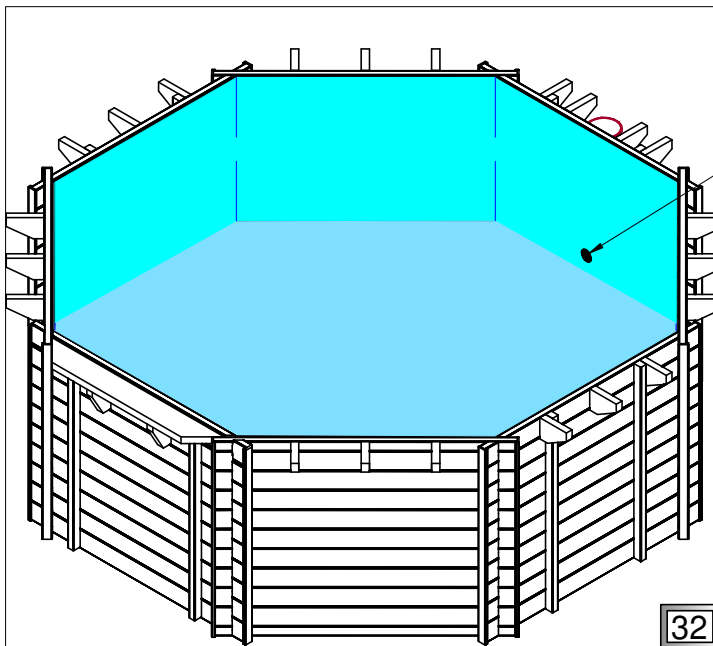
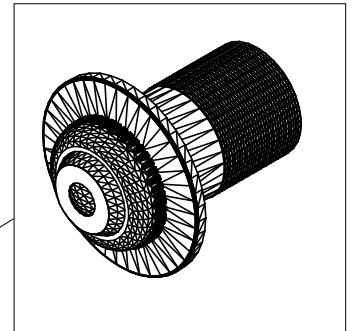
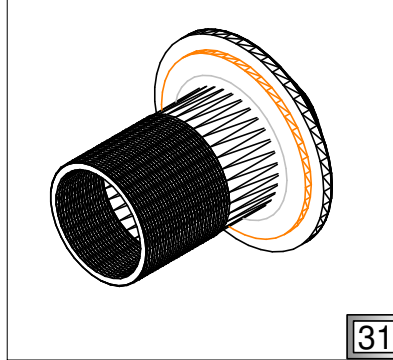
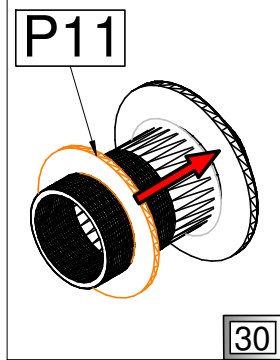
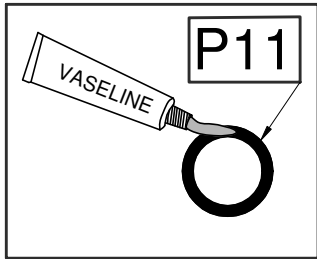
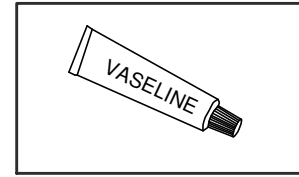
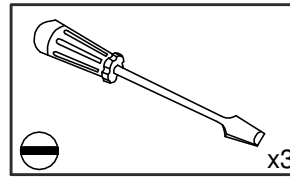
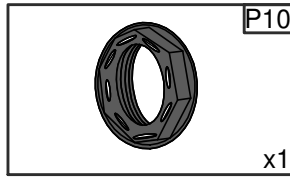
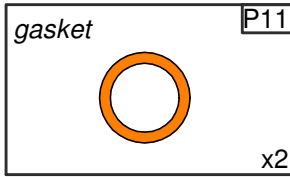

**(PL) Dysze**

**(GB) Nozzles**

**(D) Düsen**

**(FR) Les buses de refoulement**

**(IT) Ugelli**

**(NL) Inlaat**



- (PL)** Pokryj gwint dysz taśmą teflonową.
- (FR)** Mettez le ruban teflon sur la partie fileté de la buse.
- (GB)** Cover thread of hose connector with teflon tape.
- (IT)** Ricoprire il filetto degli ugelli con il nastro di teflon.
- (D)** Bedecken Sie die Düsengewinde mit dem Teflonband.
- (NL)** Wikkel de schroefdraad van de slangaansluiting in met Teflon tape.

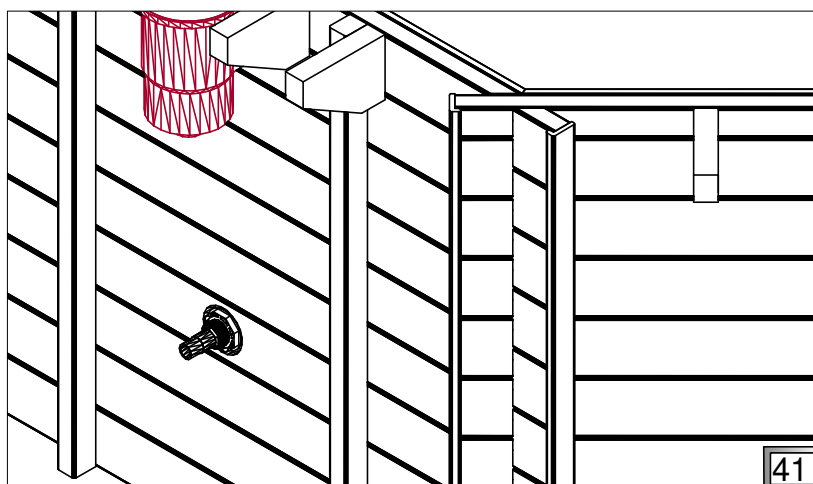
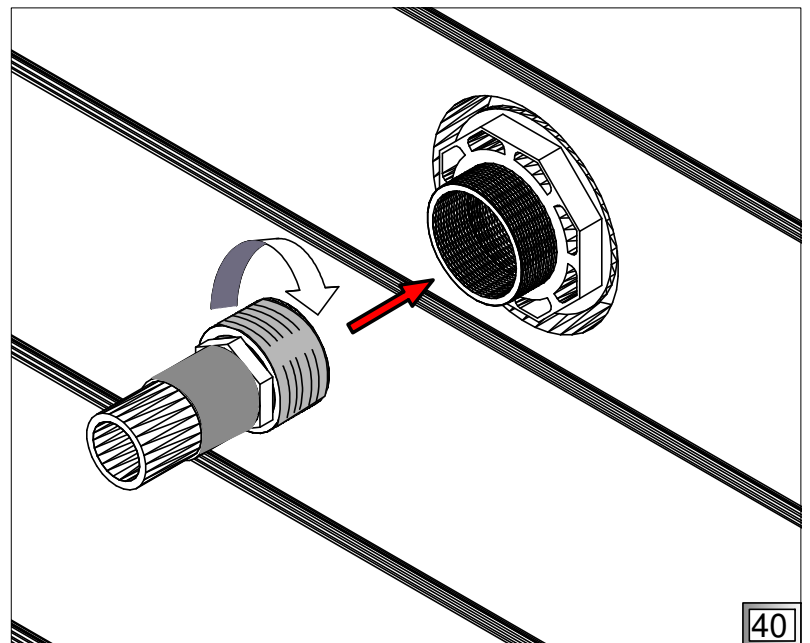
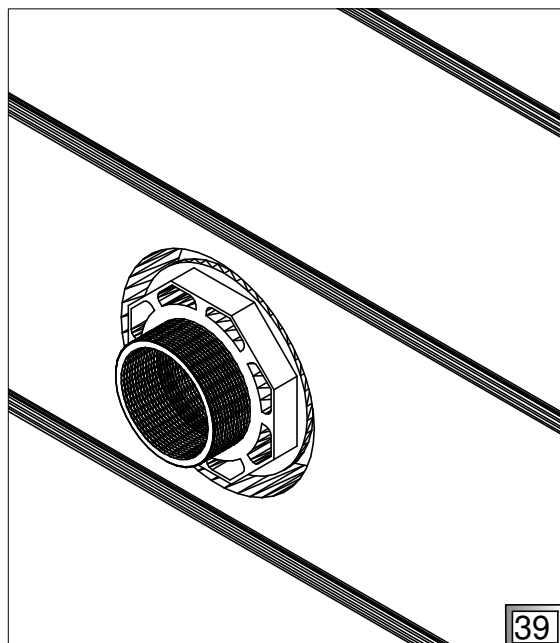
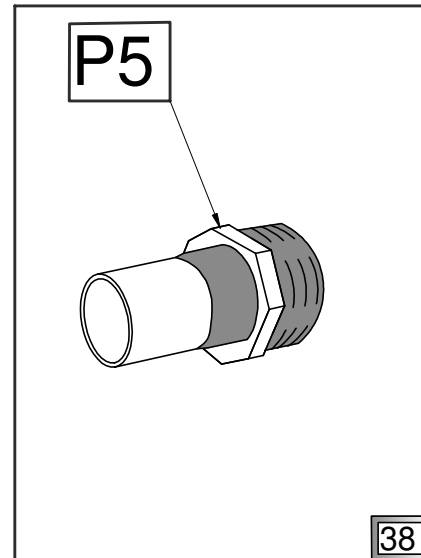
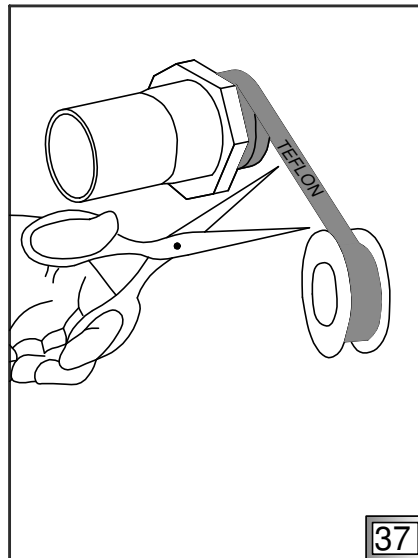
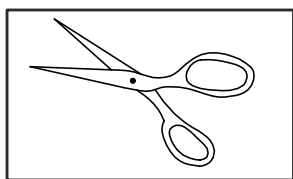
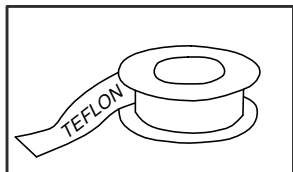
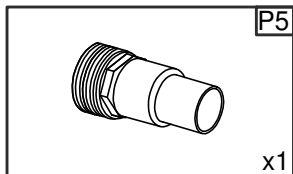

**(PL)** Napełnianie wodą

**(GB)** Filling with water

**(D)** Füllung mit Wasser

**(FR)** Le versement de l'eau

**(IT)** Riempimento con acqua

**(NL)** Vullen met water



**(PL)** Kontynuuj napełnianie wodą. Wytnij otwór w miejscu skimmera (P0).

**(FR)** Continuez à mettre de l'eau. Coupez un trou pour le skimmer (P0).

**(GB)** Keep pouring water. Cut a hole in the place of skimmer (P0).

**(IT)** Continuare a riempire con acqua. Tagliare il foro nel posto dello skimmer (P0).

**(D)** Setzen Sie das Füllen mit Wasser fort. Schneiden Sie eine Öffnung in der Stelle vom Skimmer (P0) aus.

**(NL)** Vul verder met water. Maak een gat op de plaats van de skimmer (P0).

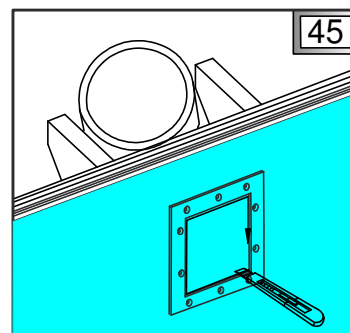
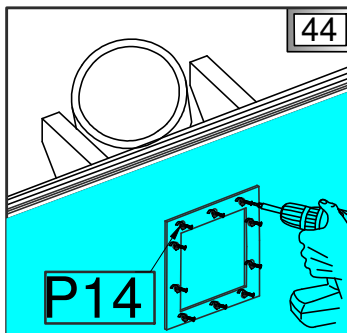
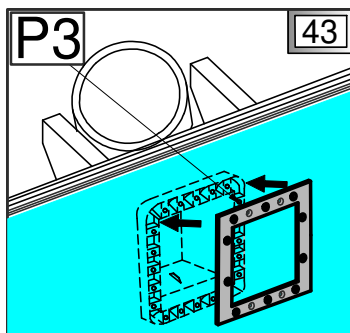
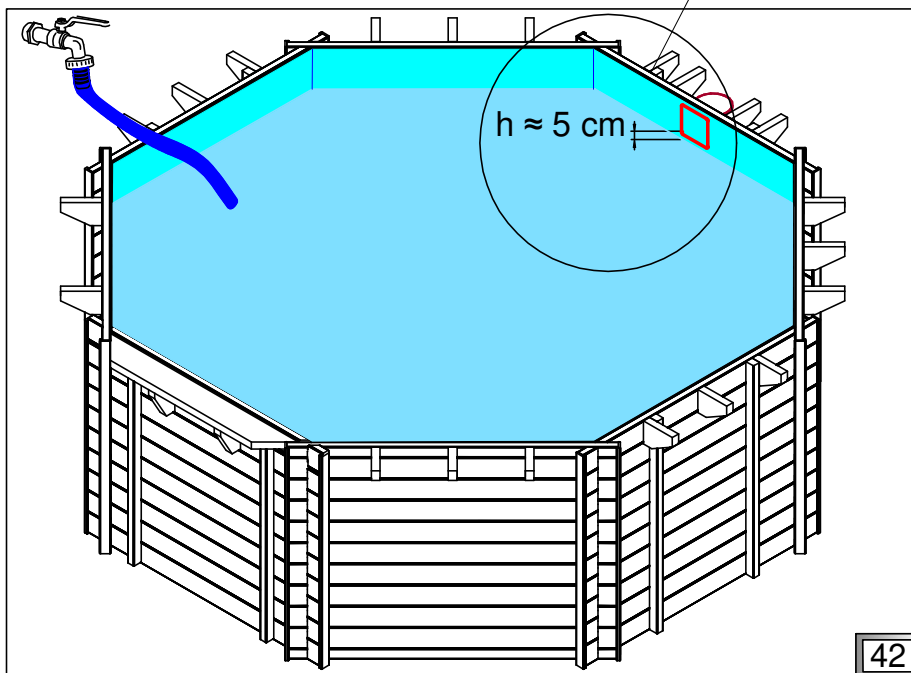
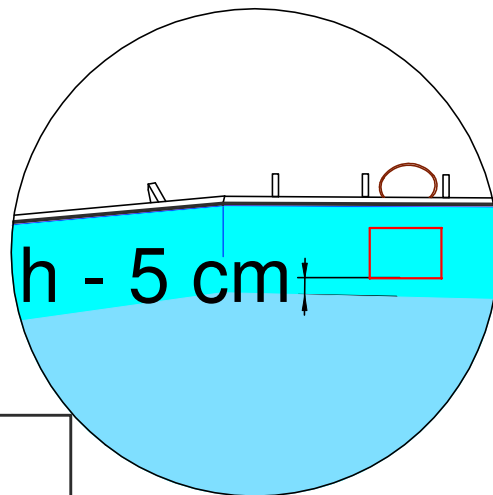
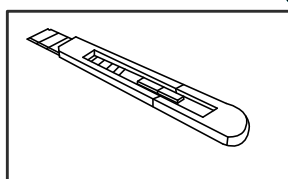
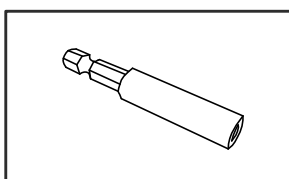
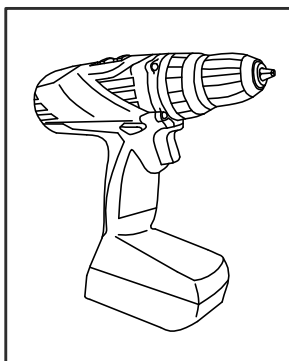
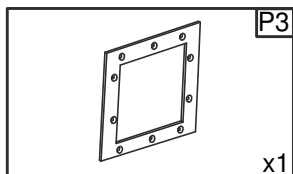
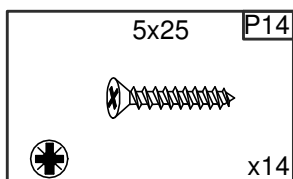
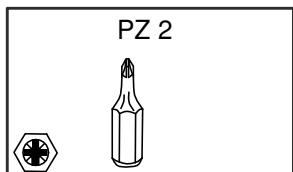
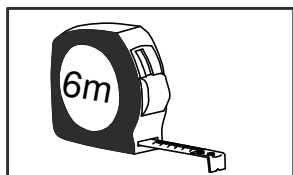

**PL** Napelnianie wodą

**GB** Filling with water

**D** Füllung mit Wasser

**FR** Le versement de l'eau

**IT** Riempimento con acqua

**NL** Vullen met water



**PL** Usuń ramkę (P3). Zamocuj uszczelkę (P4), ramkę (P3), maskownicę (P2).

**FR** Enlevez le cadre (P3). Fixez le joint (P4), le cadre (P3), le cache (P2).

**GB** Remove a frame (P3). Install gasket (P4), frame (P3), masking frame (P2).

**IT** Rimuovere la cornice (P3). Montare la guarnizione (P4), la cornice (P3), mascherino (P2).

**D** Entfernen Sie den Rahmen (P3). Legen Sie die Dichtung (P4), den Rahmen (P3), Maske (P2).

**NL** Verwijder de frame (P3) installeer de pakking (P4) monteer de frame (P3), monteer de maskeringsframe (P2).

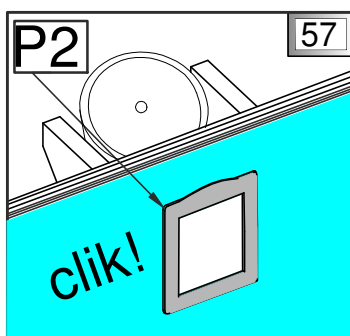
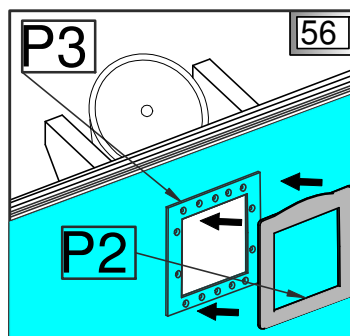
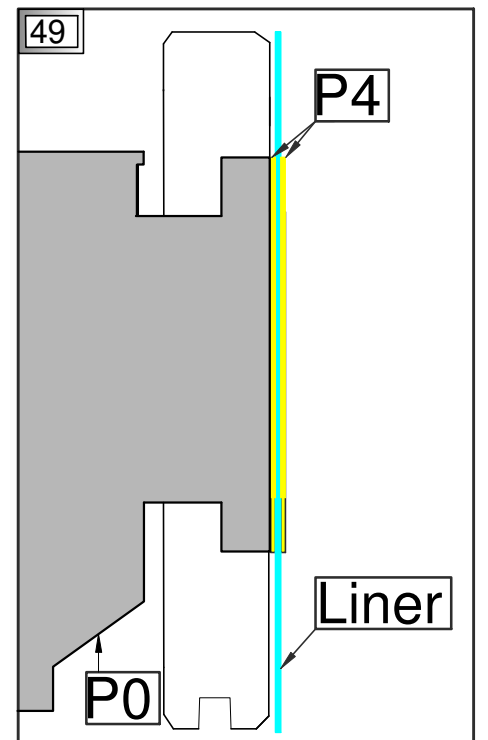
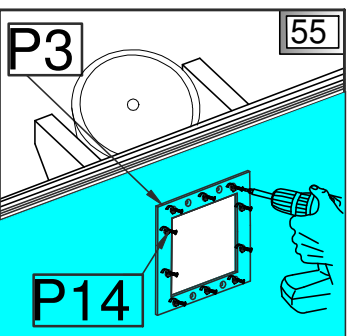
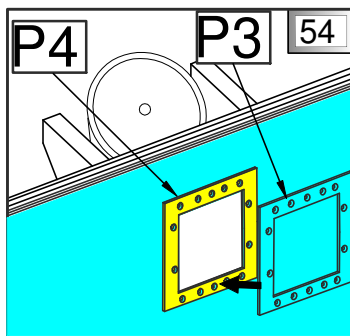
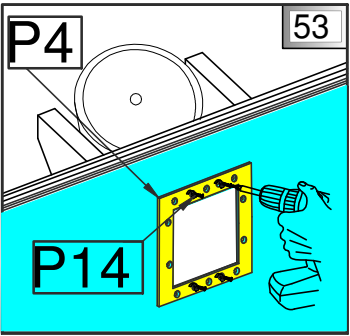
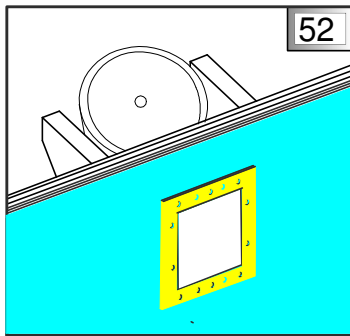
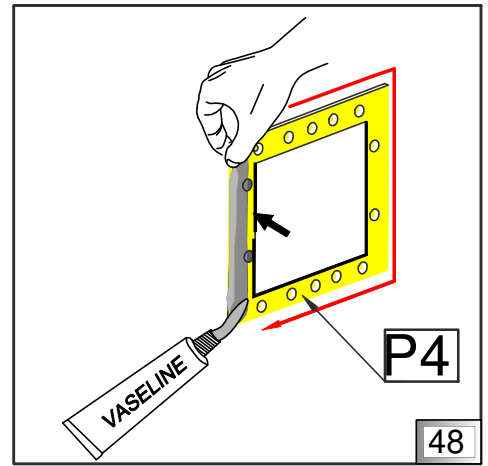
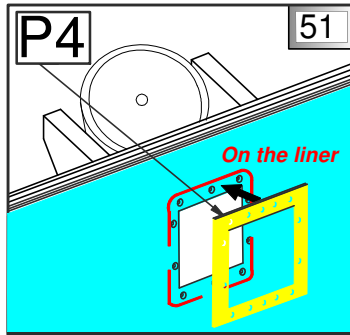
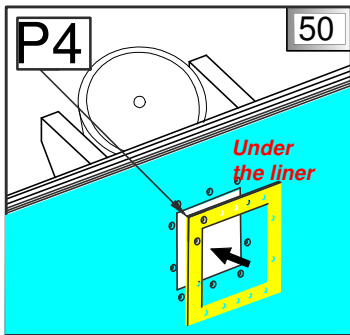
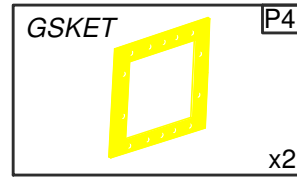
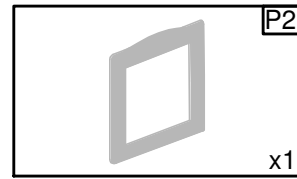
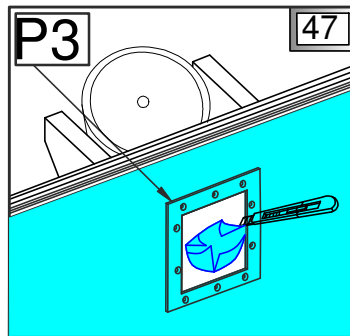
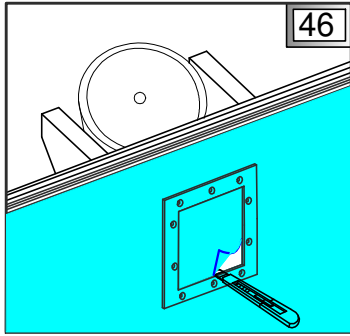

**(PL)** Napełnianie wodą

**(GB)** Filling with water

**(D)** Füllung mit Wasser

**(FR)** Le versement de l'eau

**(IT)** Riempimento con acqua

**(NL)** Vullen met water



**(PL)** Napełnij wodą do połowy wysokości maskownicy.

**(FR)** Versez de l'eau à la mi-hauteur du cadre skimmer.

**(GB)** Fill with water to the middle of the masking element.

**(IT)** Riempire con acqua a metà dell'altezza del mascherino.

**(D)** Die Hälfte von der Abdeckung ist an die Hälfte zu füllen.

**(NL)** Vul het water tot het midden van de skimmer.

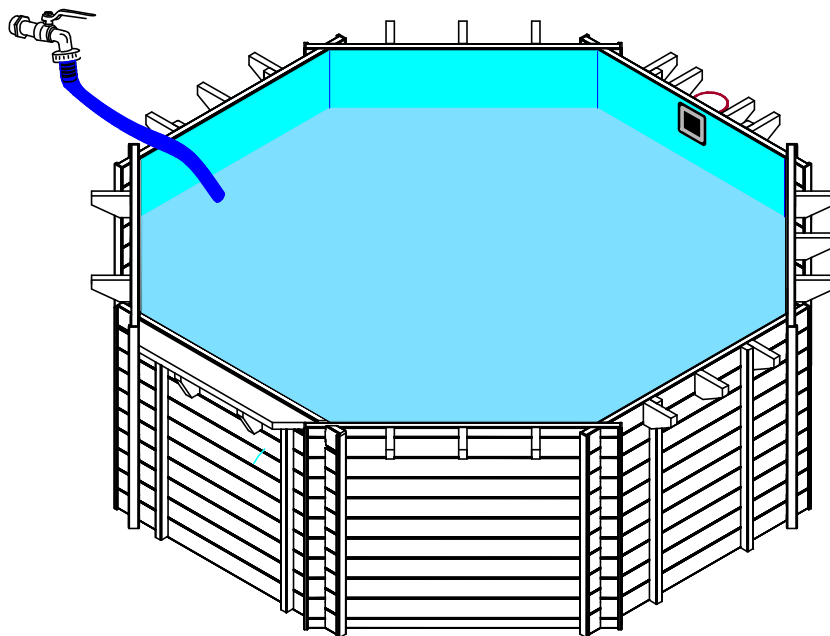

58

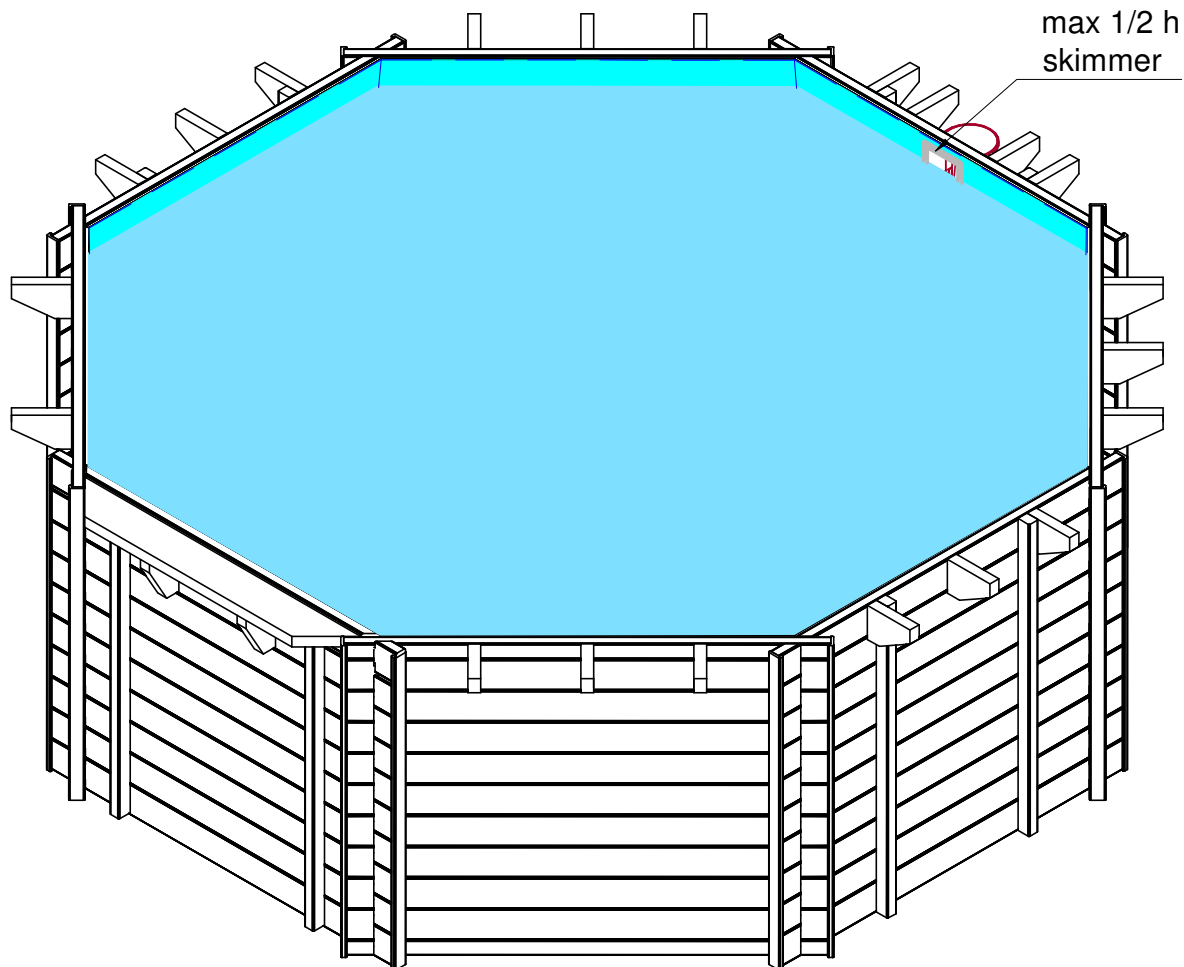

59

**PL** Taras

**GB** Terrace

**D** Terrasse

**FR** Les margelles

**IT** Terrazza

**NL** Bovenrand



- PL** Montaż desek tarasowych.
- FR** Le montage des margelles.
- GB** Installation of terrace boards.
- IT** Installazione delle tavole da terrazza.
- D** Montage vom Terrassenholz.
- NL** Installatie van de bovenrand.

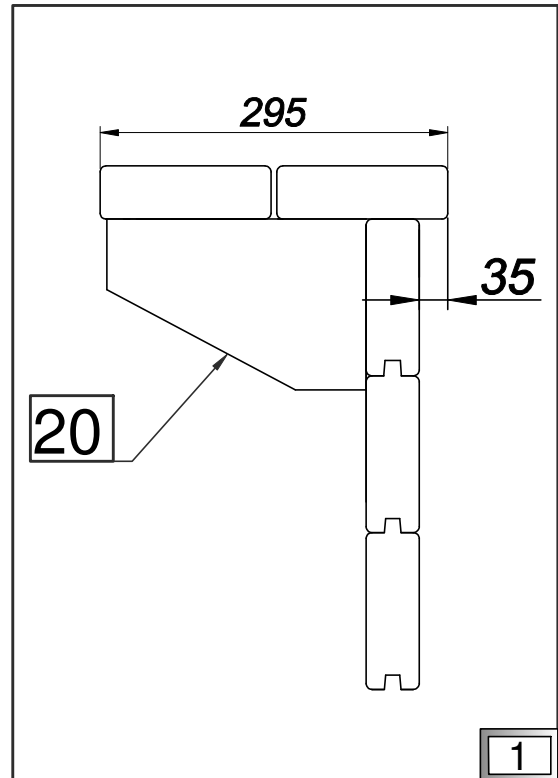
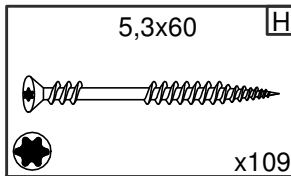
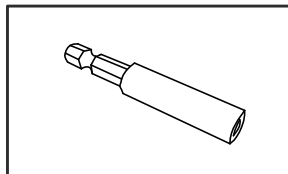
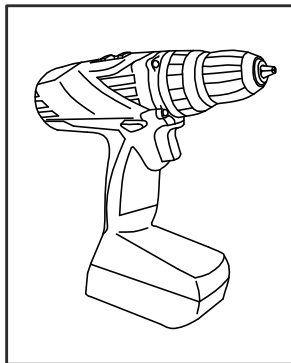
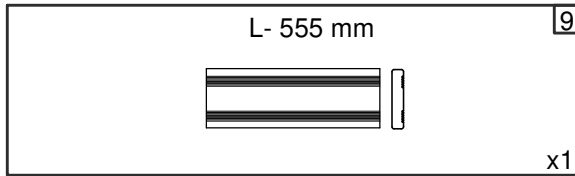
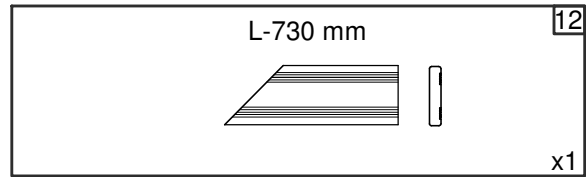
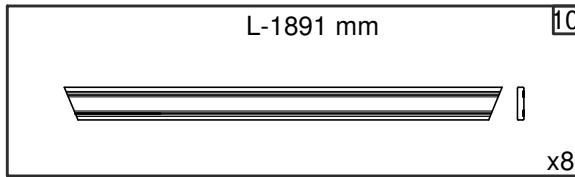
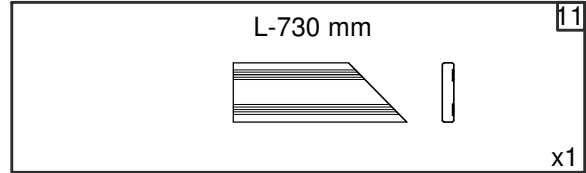
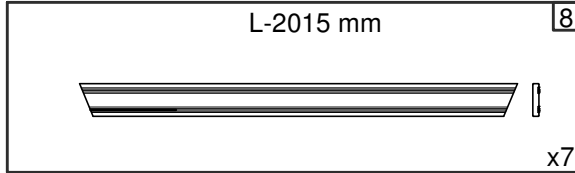



**PL** Taras

**GB** Terrace

**D** Terrasse

**FR** Les margelles

**IT** Terrazza

**NL** Bovenrand



**PL** Zamocuj deski tarsowe według rysunku 2;3.

**FR** Faites monter les margelles suivant le dessin 2;3.

**GB** Mount terrace boards according to the drawing 2;3.

**IT** Montare le tavole da terrazza secondo il disegno 2;3.

**D** Befestigen Sie das Terrassenholz nach der Abbildung 2;3.

**NL** Monteer de bovenrand volgens tekening 2;3.

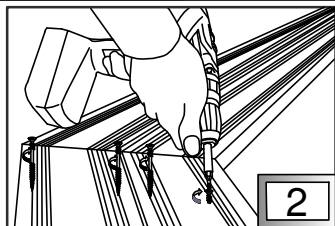

2

8

8

8

10

12

9

10

H

3

10

8

11

10

8

8

8

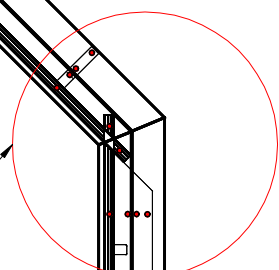

**PL** Zapięcie tarasu

**GB** Clip and hook

**D** Terrassenverschluss

**FR** Agraffes de margelles

**IT** Chiusura di terrazza

**NL** Klip en haak



**PL** Montaż zapięcia tarasu (A1, A2).

**FR** Le montage des agraffes de margelles (A1, A2).

**GB** Mounting clip and hook (A1, A2).

**IT** Montaggio della chiusura di terrazza (A1, A2).

**D** Montage vom Terrassenverschluss (A1, A2).

**NL** Installatie van de klip en haak voor de houten trap (A1, A2).

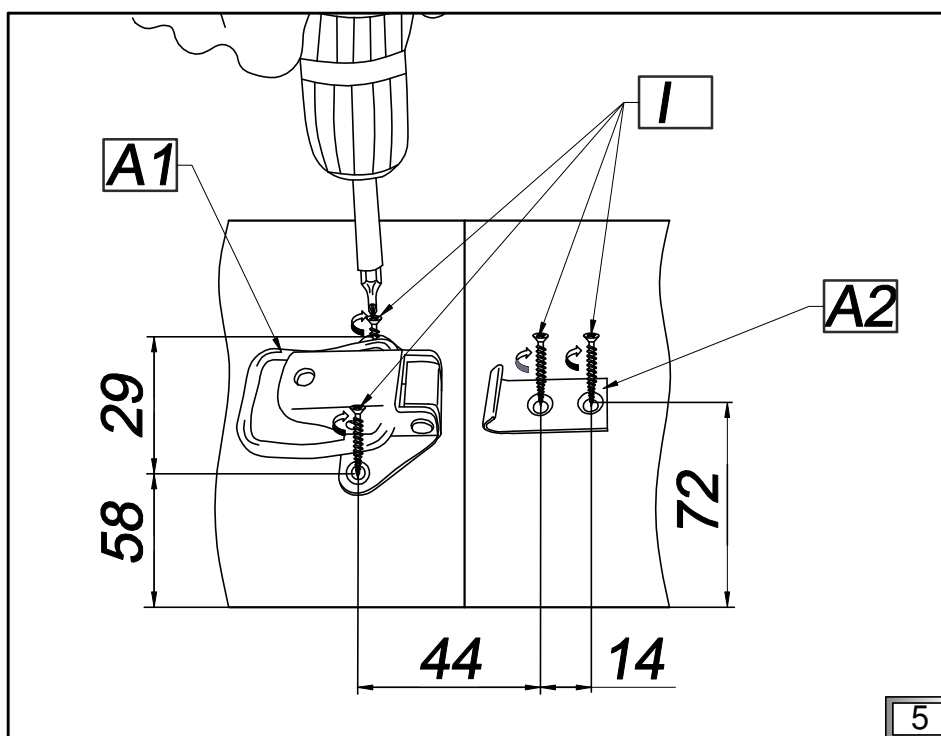
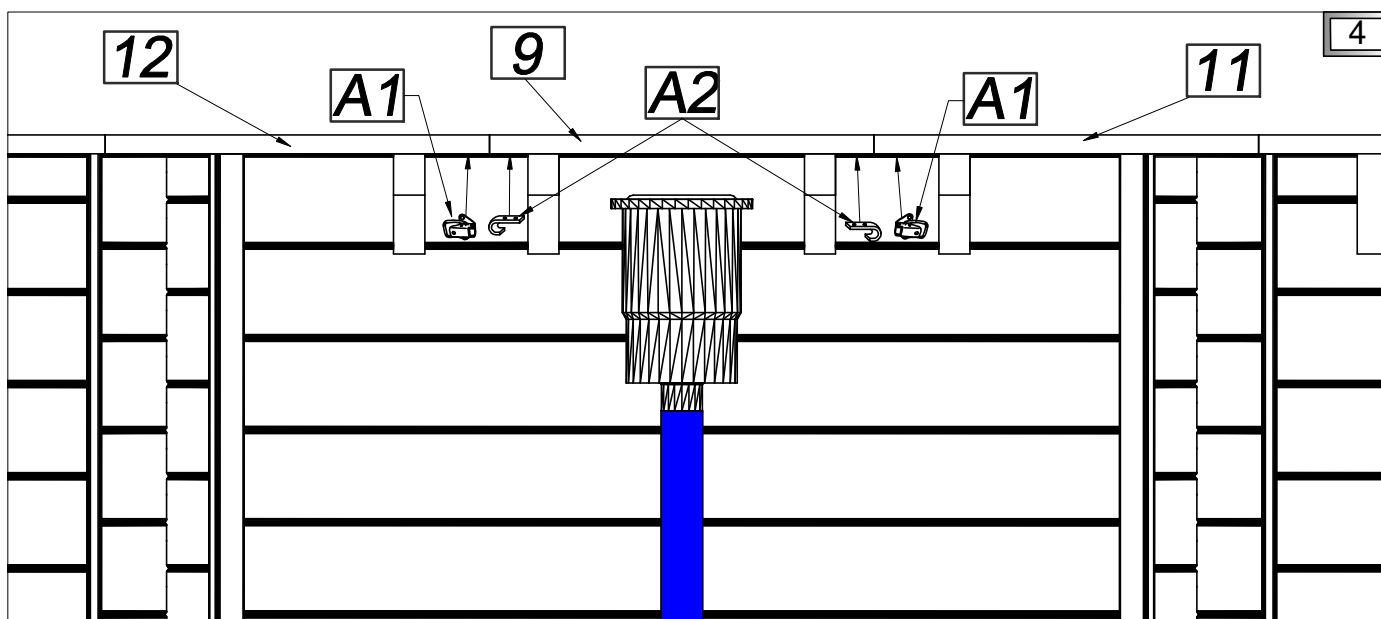
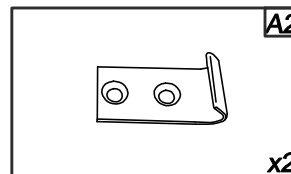
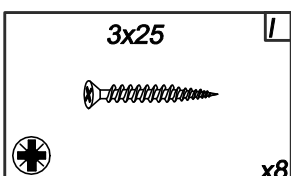
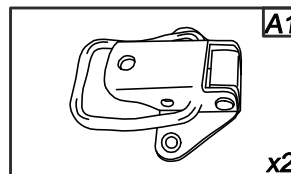
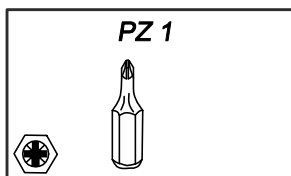
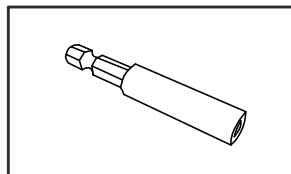
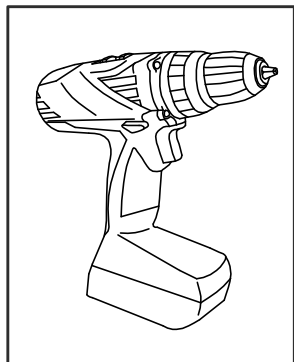

**(PL)** Struktura drewniana

**(GB)** Wooden structure

**(D)** Holzstruktur

**(FR)** La structure bois

**(IT)** Struttura in legno

**(NL)** Houten structuur



**(PL)** Montaż łącznika karo (21) od spodu desek tarasowych.

**(FR)** Le montage des jonctions (21) en dessous des margelles.

**(GB)** Installation of wooden connector (21) to the bottom of terrace boards.

**(IT)** Montaggio di raccordo (21) dal fondo delle tavole da terrazza.

**(D)** Montage vom Caro- Bindeglied (21) von der Unterseite des Terrassenholzes.

**(NL)** Installatie van de houten connector (21) aan de onderkant van de bovenranden.

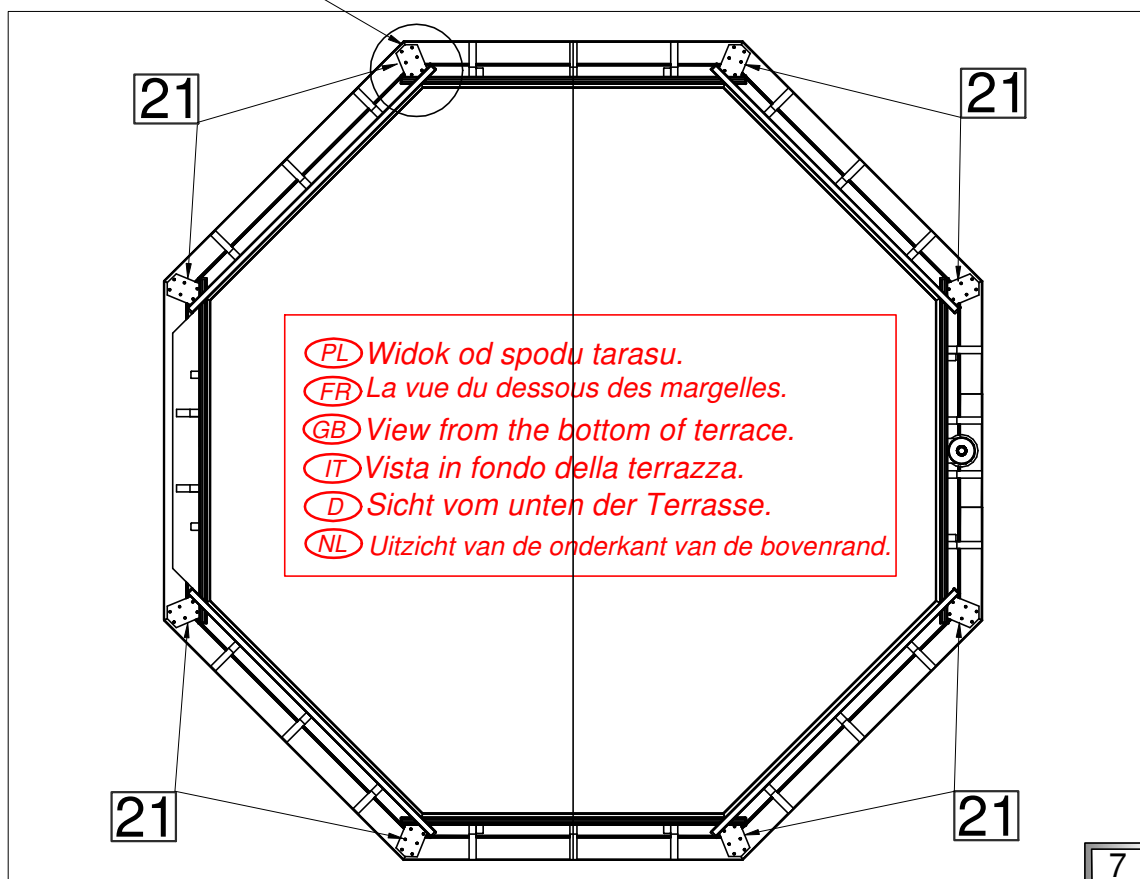
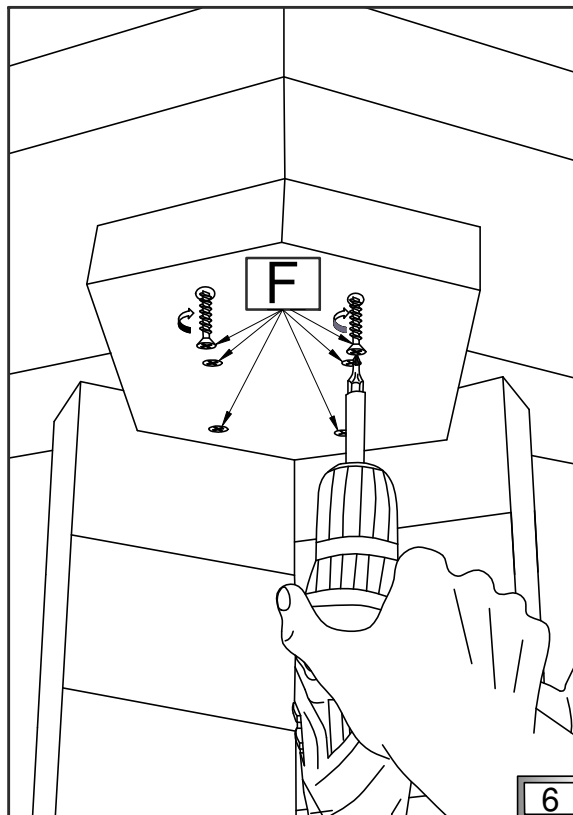
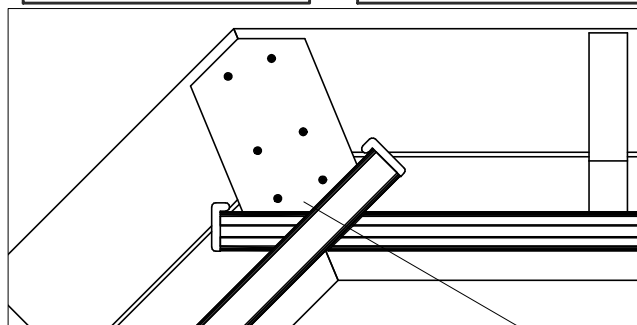
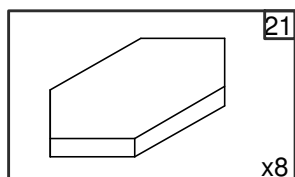
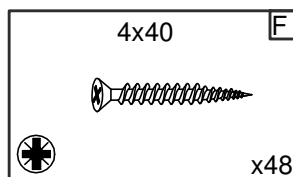
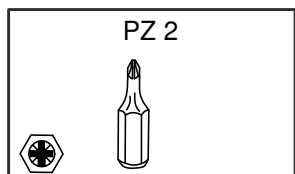
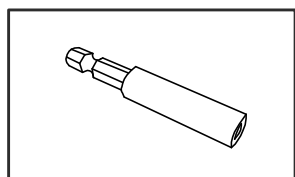
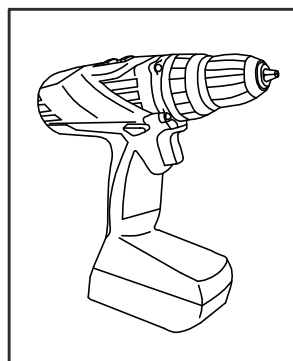

**(PL)** Widok od spodu tarasu.

**(FR)** La vue du dessous des margelles.

**(GB)** View from the bottom of terrace.

**(IT)** Vista in fondo della terrazza.

**(D)** Sicht vom unten der Terrasse.

**(NL)** Uitzicht van de onderkant van de bovenrand.

**(PL)** Schody drewniane

**(GB)** Wooden stairs

**(D)** Holztreppe

**(FR)** L'escalier bois

**(IT)** Scale di legno

**(NL)** Houten trap



**(PL)** Montaż schodów.

**(FR)** Le montage de l'escalier.

**(GB)** Installation of stairs.

**(IT)** Montaggio delle scale.

**(D)** Montage von Treppen.

**(NL)** Installatie van de houten trap.

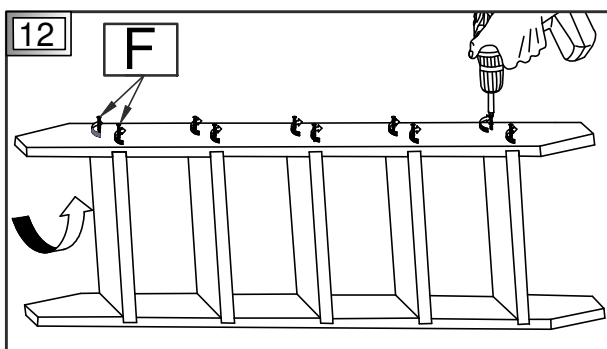
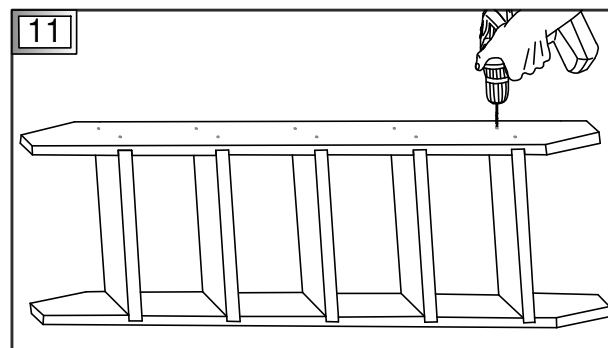
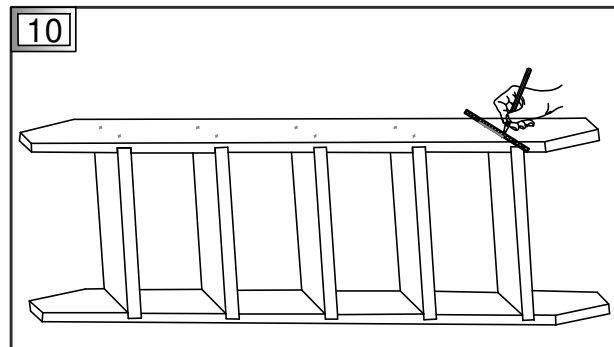
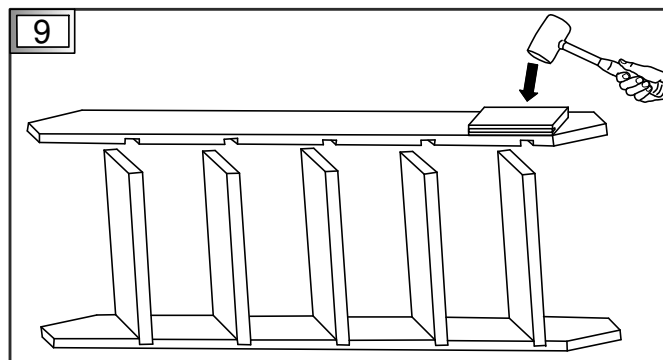
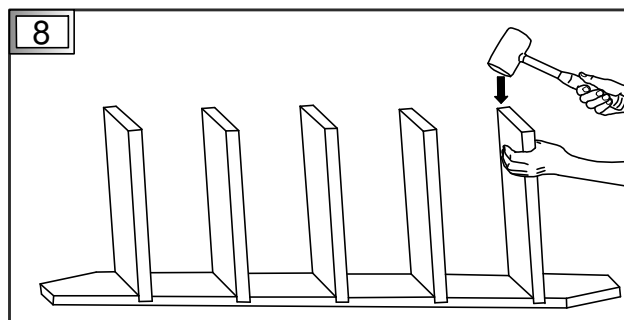
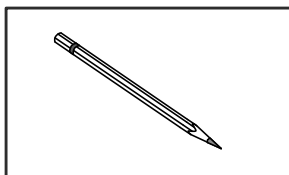
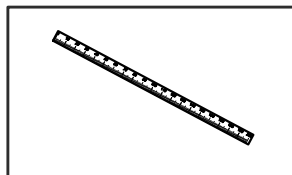
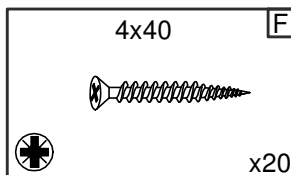
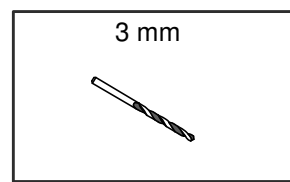
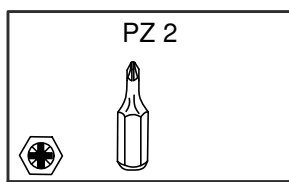
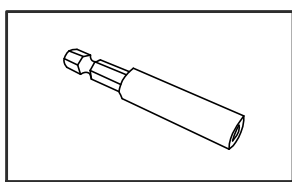
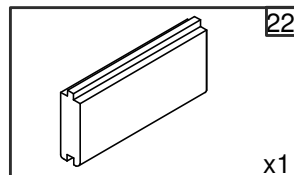
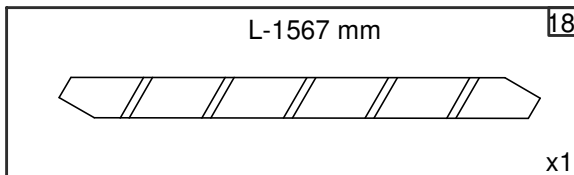
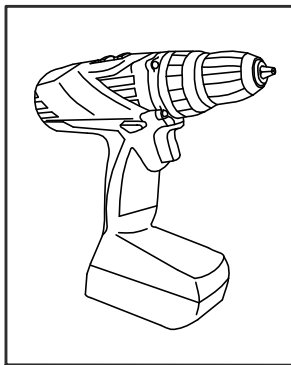
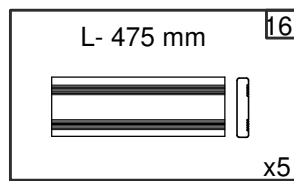
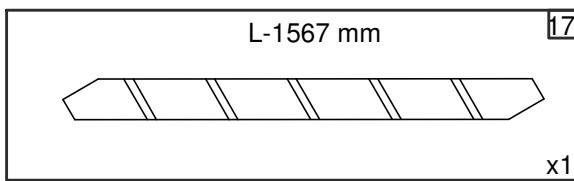
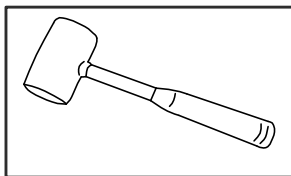

**(PL)** Schody drewniane

**(GB)** Wooden stairs

**(D)** Holztruppe

**(FR)** L'escalier bois

**(IT)** Scale di legno

**(NL)** Houten trap



**(PL)** Montaż zawieszki (B1, B2). Schody mocujemy na ścianie ze wspornikiem schodów (13).

**(FR)** Le montage des boucles et des gâches (B1, B2). Fixez l'escalier sur la paroi avec le renfort d'escalier (13).

**(GB)** Installation of tag and hook kit (B1, B2). Stairs are mounted on the wall with stairs support (13).

**(IT)** Montaggio del manico (B1, B2). Le scale sono fissate al muro con uno sbalzo di scale (13).

**(D)** Montage vom Gehänge (B1, B2). Die Treppe ist an die Wand mit Treppenstützen (13) zu montieren.

**(NL)** Installatie van het inhaak systeem (B1, B2) trap wordt aan de bovenrand gemonteerd (13).

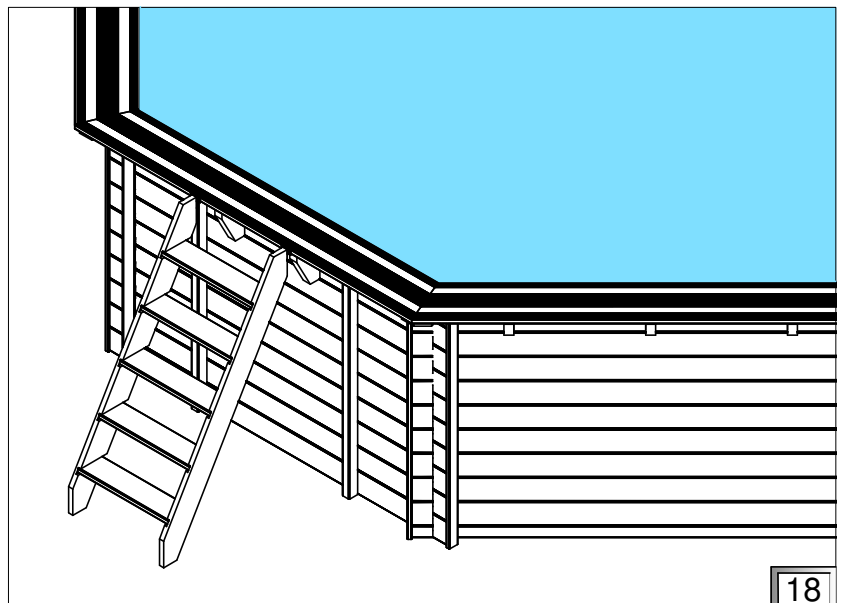
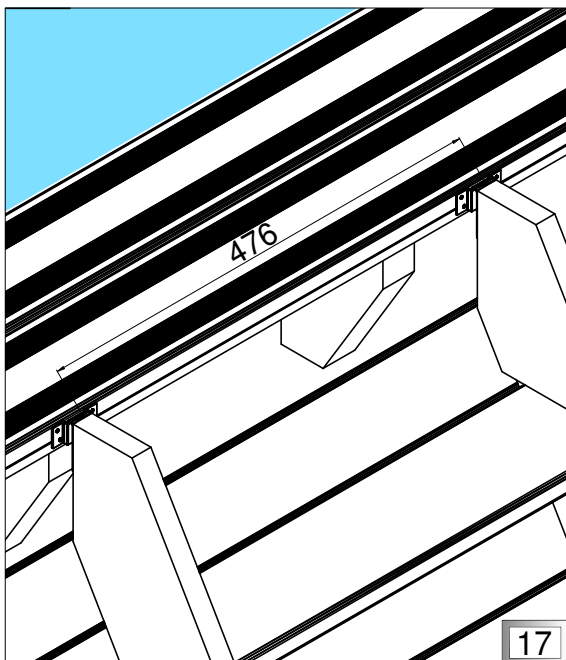
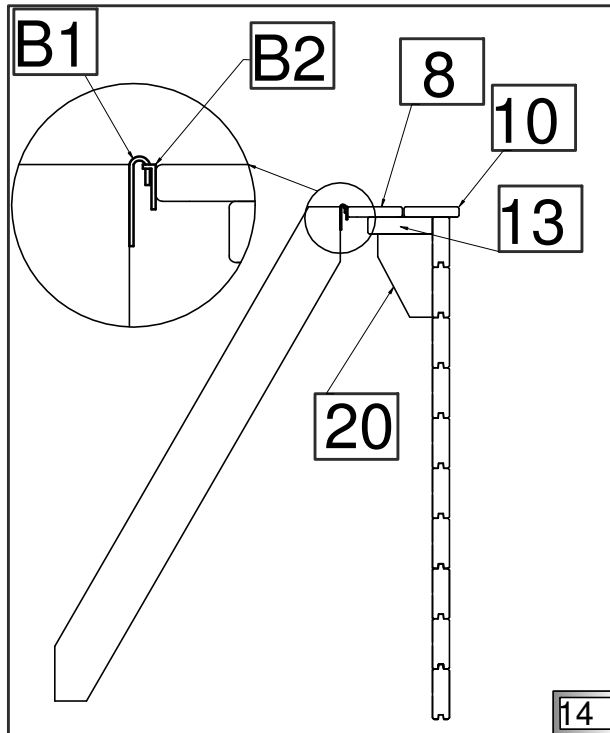
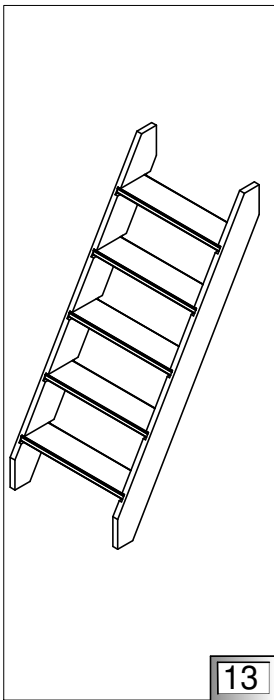
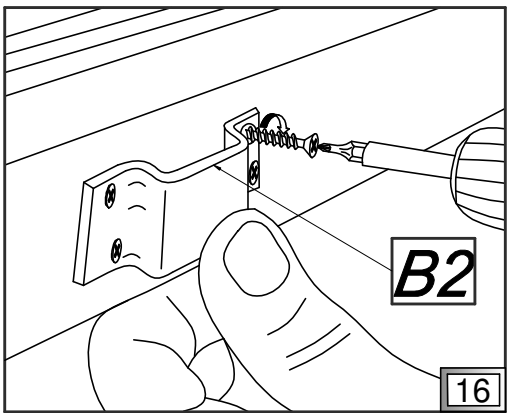
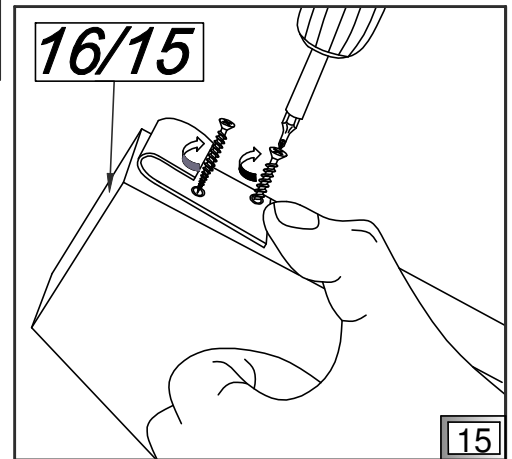
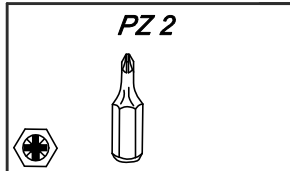
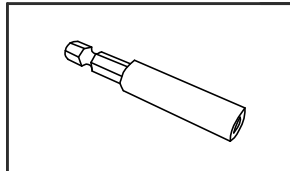
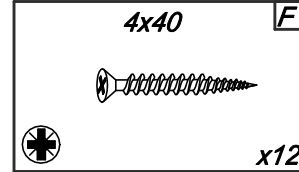
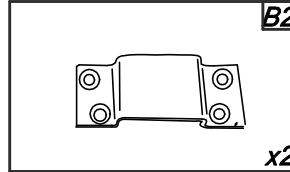
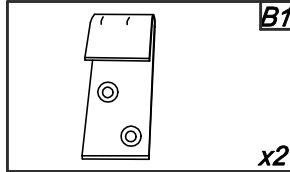
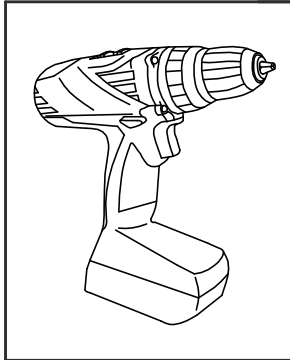

**(PL)** Drabinka stalowa

**(GB)** Stainless steel ladder

**(D)** Metallleiter

**(FR)** L'échelle inox

**(IT)** Scaletta in acciaio

**(NL)** Roestvrij stalen ladder



**(PL)** Montaż stalowej drabinki wewnętrznej do desek tarasowych.

**(FR)** La fixation de l'échelle inox aux margelles.

**(GB)** Mounting stainless steel ladder to the terrace boards.

**(IT)** Montaggio della scala interna alle tavole da terrazza.

**(D)** Montage von der Innenleiter aus Stahl ans Terrassenholz.

**(NL)** Installation of stainless steel ladder.

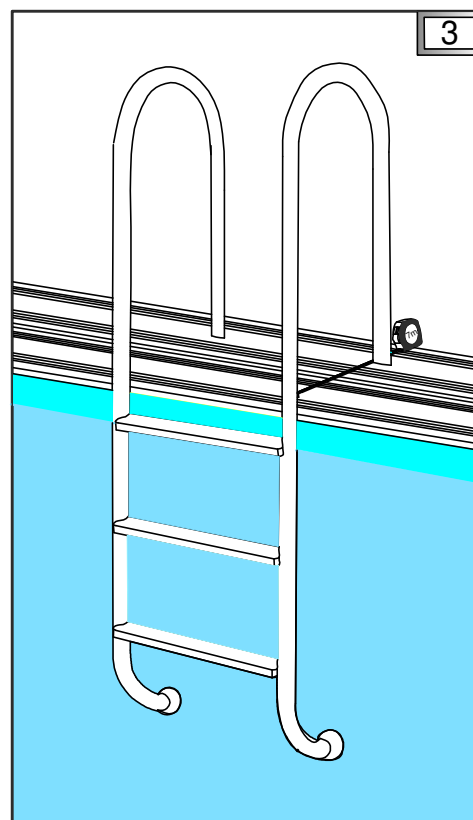
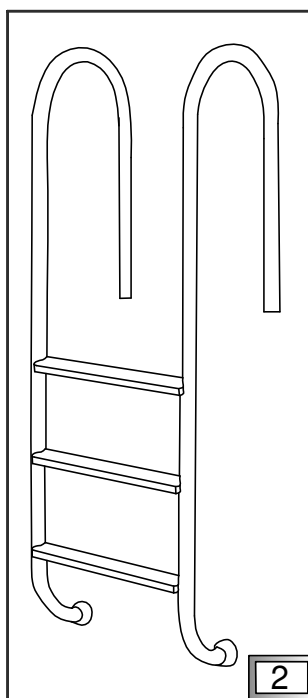
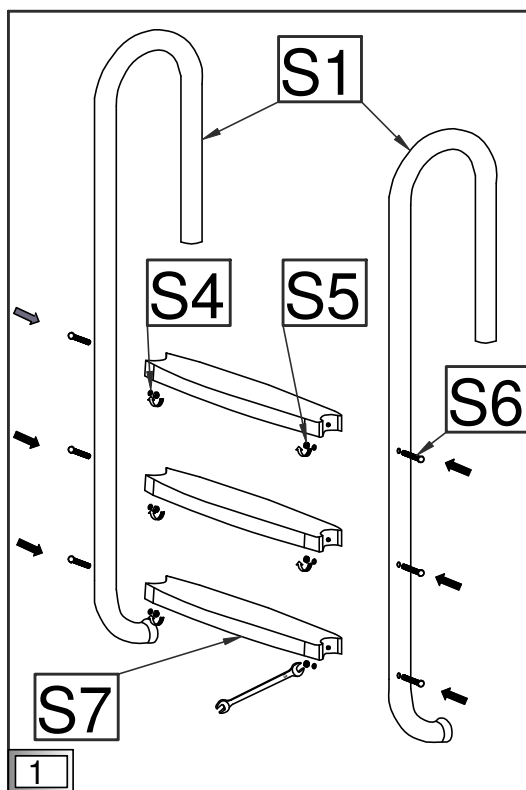
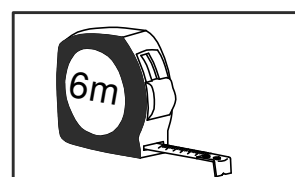
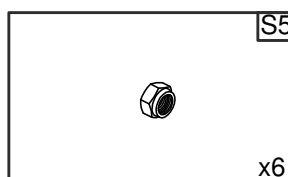
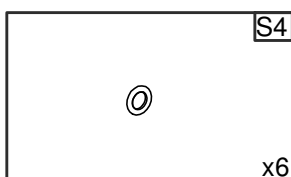
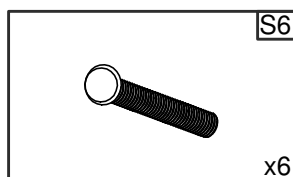
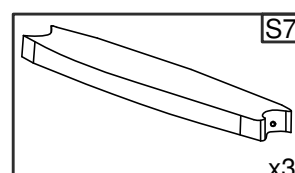
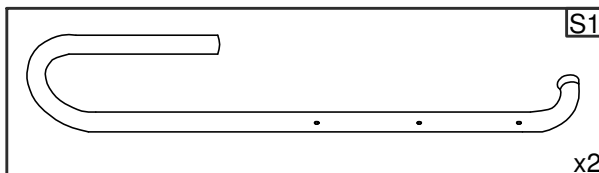
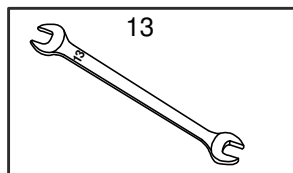

**(PL)** Drabinka stalowa

**(GB)** Stainless steel ladder

**(D)** Metallleiter

**(FR)** L'échelle inox

**(IT)** Scaletta in acciaio

**(NL)** Roestvrij stalen ladder



**(PL)** Montaż stalowej drabinki wewnętrznej do desek tarasowych.

**(FR)** La fixation de l'échelle inox aux margelles.

**(GB)** Mounting stainless steel ladder to the terrace boards.

**(IT)** Montaggio della scala interna alle tavole da terrazza.

**(D)** Montage von der Innenleiter aus Stahl ans Terrassenholz.

**(NL)** Montage roestvrij stalen ladder op de terras planken

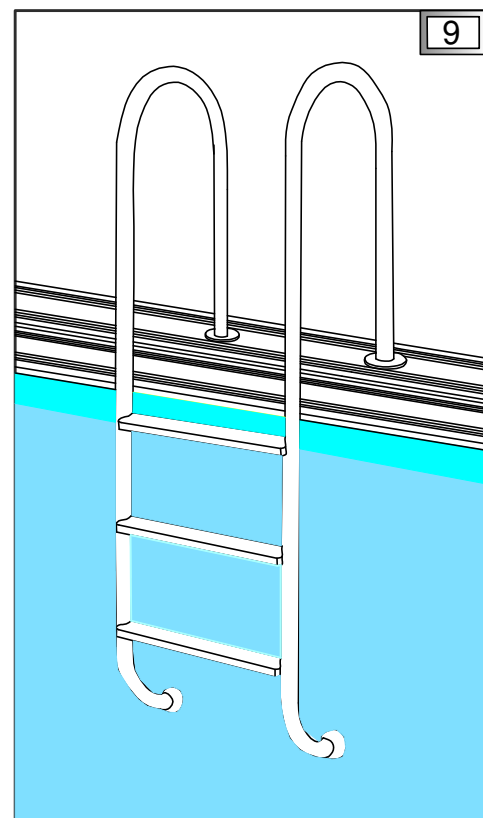
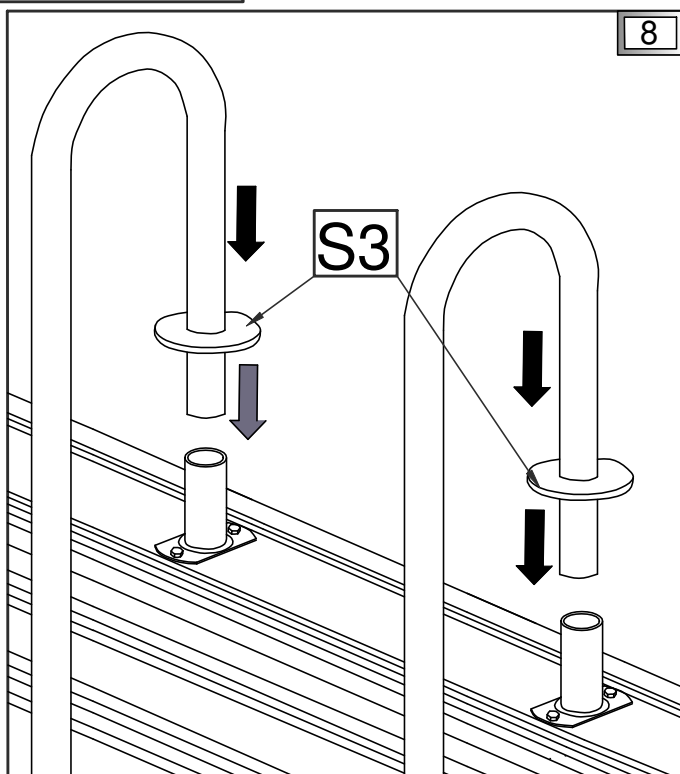
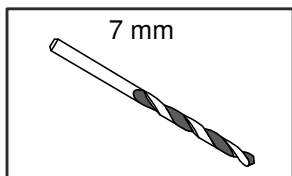
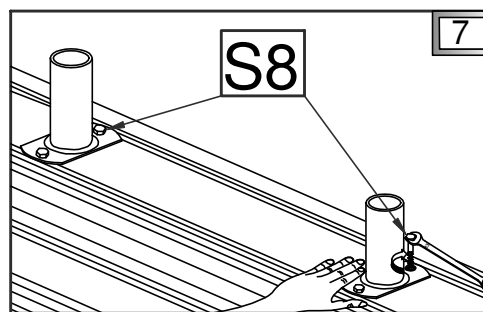
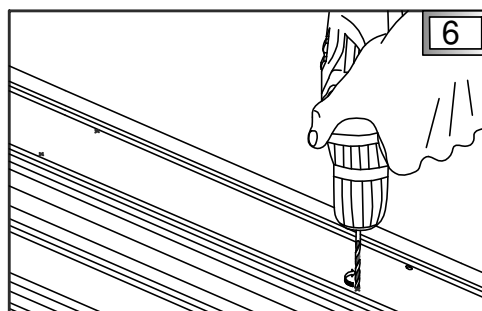
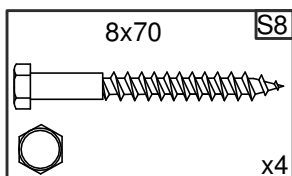
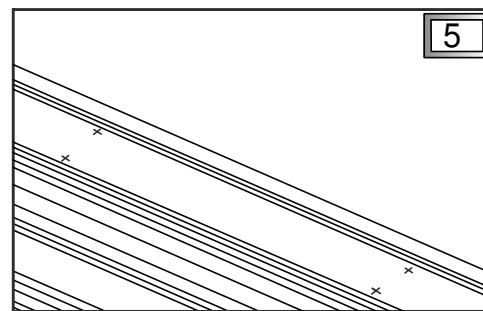
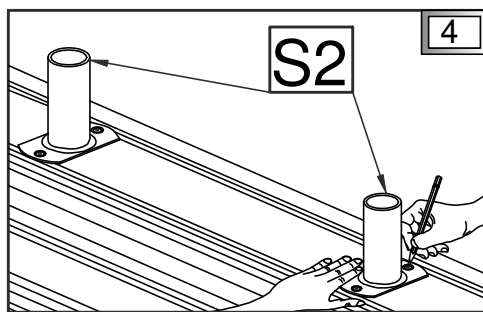
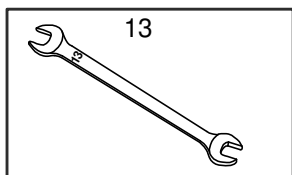
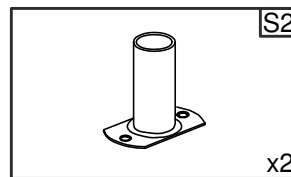
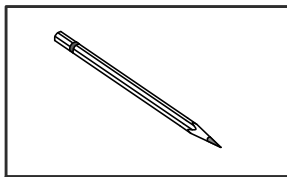
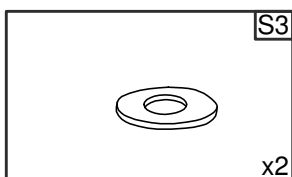
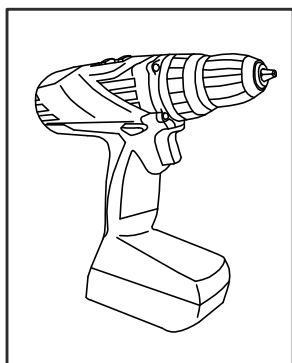

**(PL)** Drabinka stalowa

**(GB)** Stainless steel ladder

**(D)** Metalleiter

**(FR)** L'échelle inox

**(IT)** Scaletta in acciaio

**(NL)** Roestvrij stalen ladder



**(PL)** Montaż stalowej drabinki wewnętrznej.

**(FR)** La fixation de l'échelle inox.

**(GB)** Mounting stainless steel ladder .

**(IT)** Montaggio della scaletta in acciaio.

**(D)** Montage von der Innenleiter aus Stahl.

**(NL)** Montage roestvrij stalen ladder.

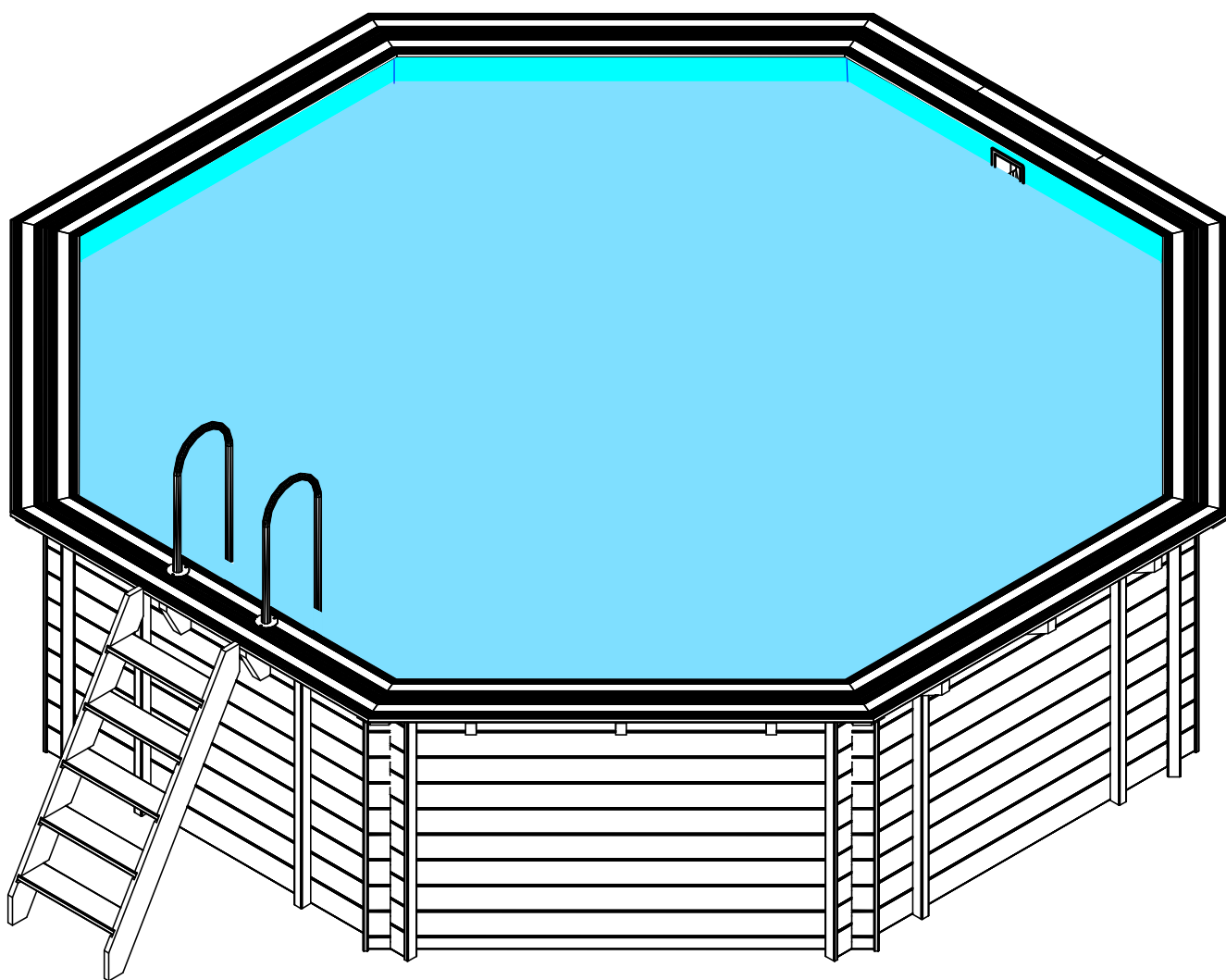



(PL) Maskownice

(GB) Corners covers

(D) Abdeckungen

(FR) Les caches

(IT) Mascherini

(NL) Afdekkappen



(PL) Montaż maskownic (Y) do desek tarasowych.

(FR) Le montage des caches (Y) pour les margelles.

(GB) Mounting covers (Y) for corners of terrace boards.

(IT) Montaggio di mascherini (Y) per le tavole da terrazza.

(D) Montage der Abdeckungen (Y) ans Terrassenholz.

(NL) Roest vrij afdekkappen (Y) voor de hoeken van de boven rand.

